



A-look™

PANEL FITMENT SYSTEM

MODEL:
ASHBURY & ASHBURY-AL
PROVIDENCE & PROVIDENCE-AL
AVANT-GARDE
VICTORIA PARK
FITZROY

INSTALLATION INSTRUCTIONS



CAB COMPONENTS TO BE INSTALLED

A-Look Panel Interlock

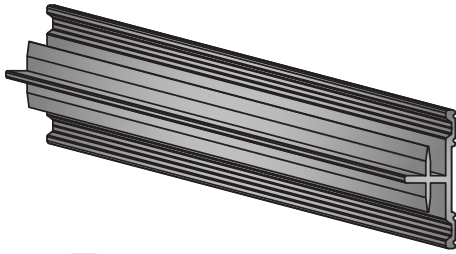

Half Panel Interlock (starter strip)

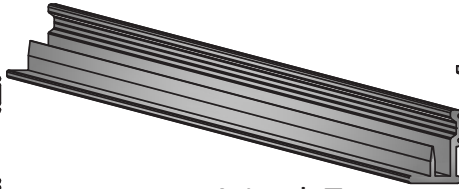

A-Look Panel Edge

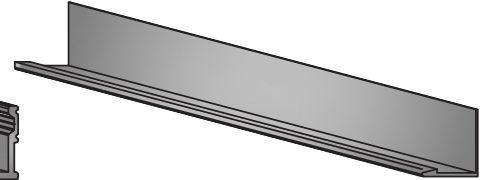

A-Look Top Cap Panel

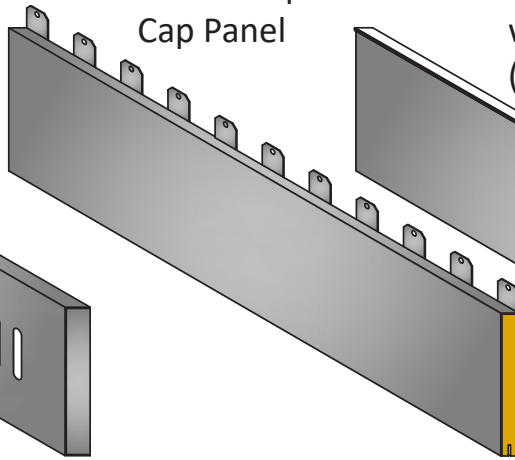

A-Look Top Cap Panel with half interlock (for wall finish only cabs)

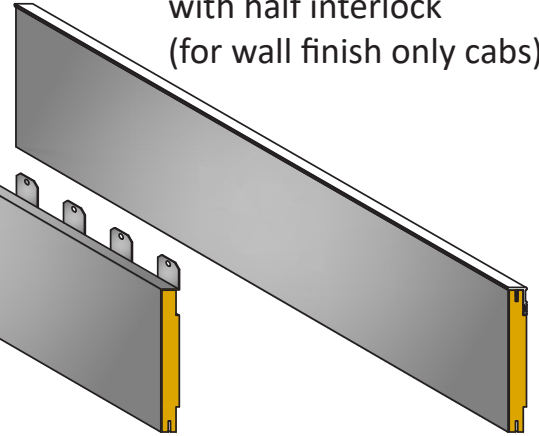

Vented Removable Kick Plate

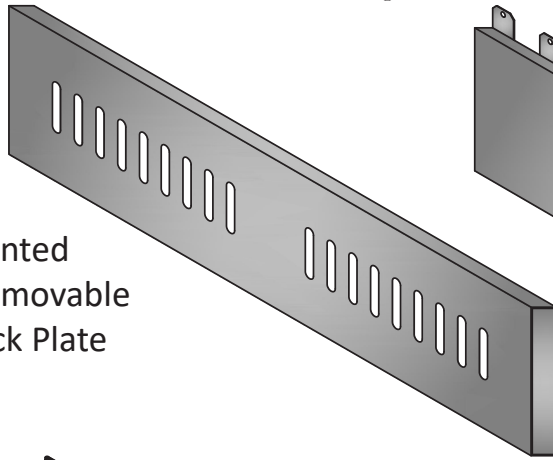

Handrail Panel complete with "Panel Interlock"

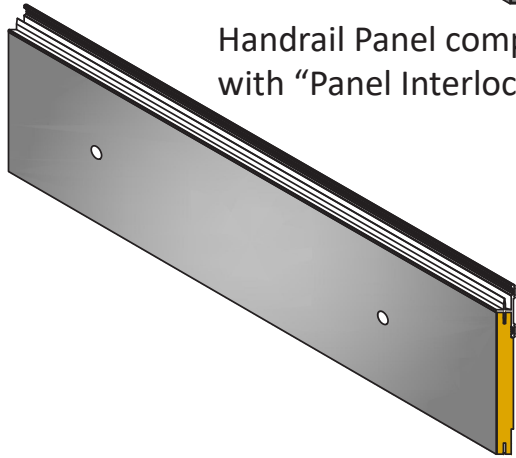

Separate Handrail
may not be as shown

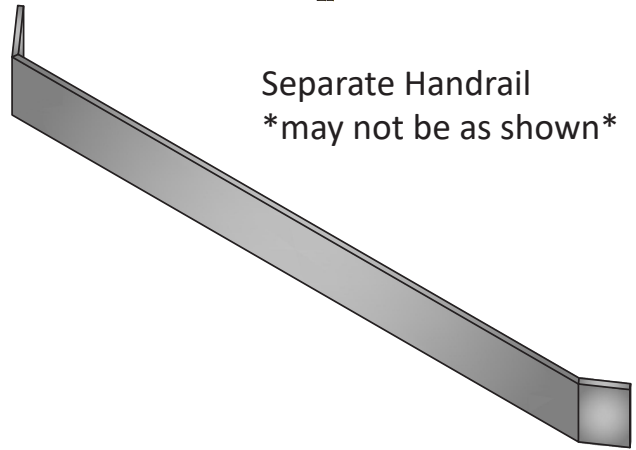

Several panels complete with "panel interlock", covered in plastic laminate, mirror, or decorative metal.

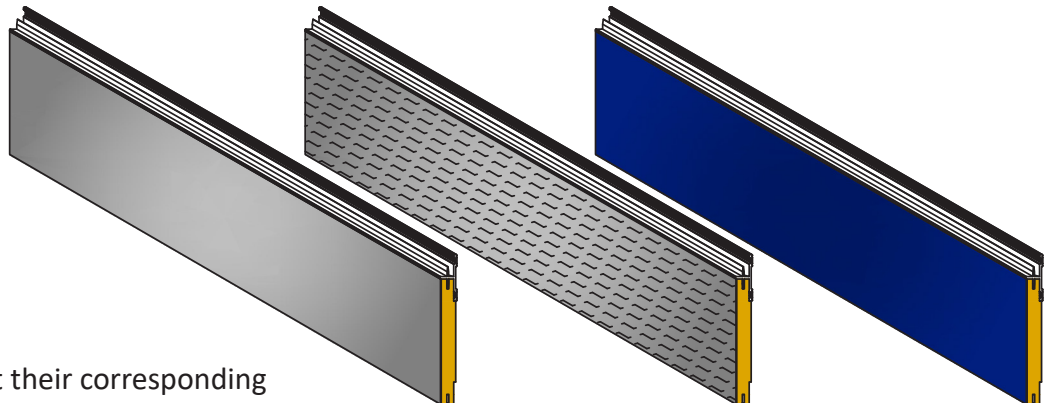

Pieces are pre-sized to fit their corresponding wall. All parts will be marked as illustrated in the Cab Component Labelling Diagram.

TOOLS REQUIRED

- Measuring Tape
- Drill
- Frame Square
- Ladder
- 2" or 3" Paint Brush for Latex Paint
- Rivet Gun
- **Suction Cups x2 (strongly recommended)**

CAB COMPONENT LABELLING

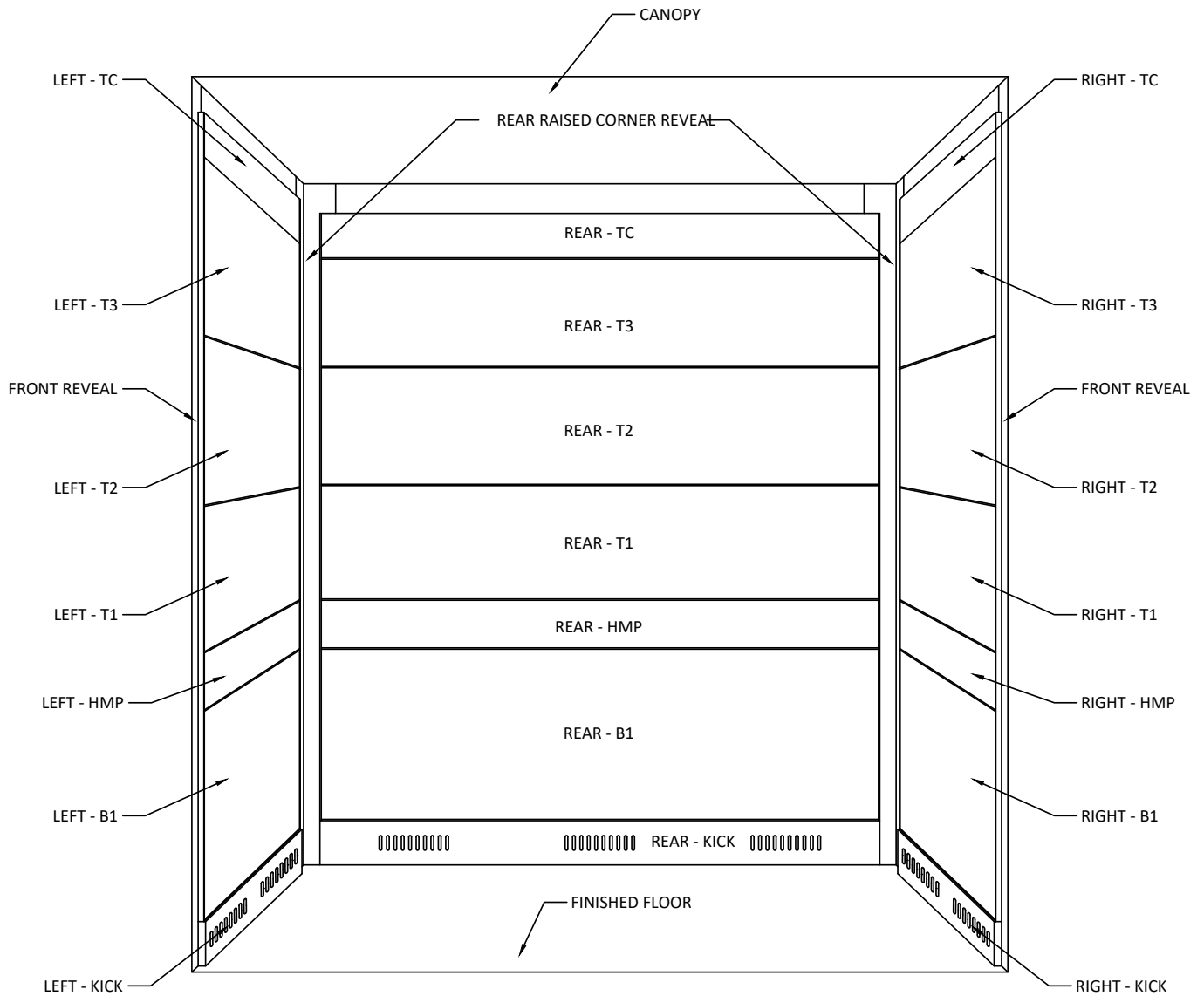

Dia. 1

SECTION 1: UNPACKING

- 1.1. When your new A-Look™ cab arrives, transport it near to the cab you will be renovating and organize the crates so that they will be easily accessible.

The crate's contents are itemized on its surface.

One box will be labelled "Open First". It contains the drawings, instructions, hardware & adhesive.

- 1.2. Carefully un-crate the cab package, making sure that none of the components are damaged.
- 1.3. Check the colours, features, and dimensions of the components against your order before you begin removing the existing elevator interior.
- 1.4. Note the labelling on the components on the previous page. The labels indicate the order in which the components will be installed and will help you identify the correct component called for in the instructions.

If you have any questions at this point, contact ECR before going ahead with any part of the installation.



Note: The interlock extrusions are not attached to the panels. The extrusions are designed to be removed should the panels need to be reversed.



Warning: Do not lift the panels by the extrusions.

For technical support on the A-Look Panel installation, please contact us at:

Elevator Cab Renovations
Office: (613) 745-4870
Toll Free: 1-877-745-4870
ecr@elevatorcabs.ca

Office Hours : 6:30 AM to 3:30 PM Eastern Standard Time

SECTION 2: PREPARE SITE FOR INSTALLATION

- 2.1. Remove all materials being replaced from the existing cab, stripping the cab down to the bare shell. Clean any debris and oil from the cab shell.
- 2.2. If the drop ceiling is being replaced, paint the perimeter of the canopy 4" in from all sides with matte black latex paint (paint is not included). The remainder of the canopy will not be visible once the new ceiling is installed.
- 2.3. If the floors are being replaced, remove existing floor and install new flooring before installing the A-Look panels. If the floors are not being replaced, use a protective covering to prevent damage to the floor.

SECTION 3: INSTALL CAB REVEALS

- 3.1. Dry fit the front and rear corner reveals and trim reveals as necessary. Reveals can be up to 1/4" short of the canopy without affecting the final look of the cab (Dia. 2).
- 3.2. If your shell has a protruding header, split the reveal where the step occurs and fit the remaining reveal piece against the step as indicated by the red dashed line (Dia. 2).
- 3.3. Apply the supplied 2-sided tape to the back side of reveals.
- 3.4. Starting at the bottom press the reveals onto the cab shell, ensuring a tight fit against the corners and flush to the floor. Apply pressure to ensure the reveal adheres to the cab shell.
- 3.5. A drop ceiling will block the canopy from view; if your cab has a drop ceiling, or a drop ceiling was purchased, paint the shell walls below the canopy and between the reveals with matte black latex paint (not included). The top cap normally sits 4 inches below the canopy; paint at least 5 inches below the canopy (Dia. 2).
- 3.6. If the top cap will be visible, stainless steel horizontal reveals will be included. Fit the reveals tight against the canopy between the corner-corner and corner-front reveals, trimming if necessary. Apply the reveals to the shell with 2-sided tape.



Note: It is important to remove the protective plastic from the reveals before continuing the installation. Once the kick plates are installed the protective plastic is difficult to remove.

SECTION 3: INSTALL CAB REVEALS (CONTINUED)

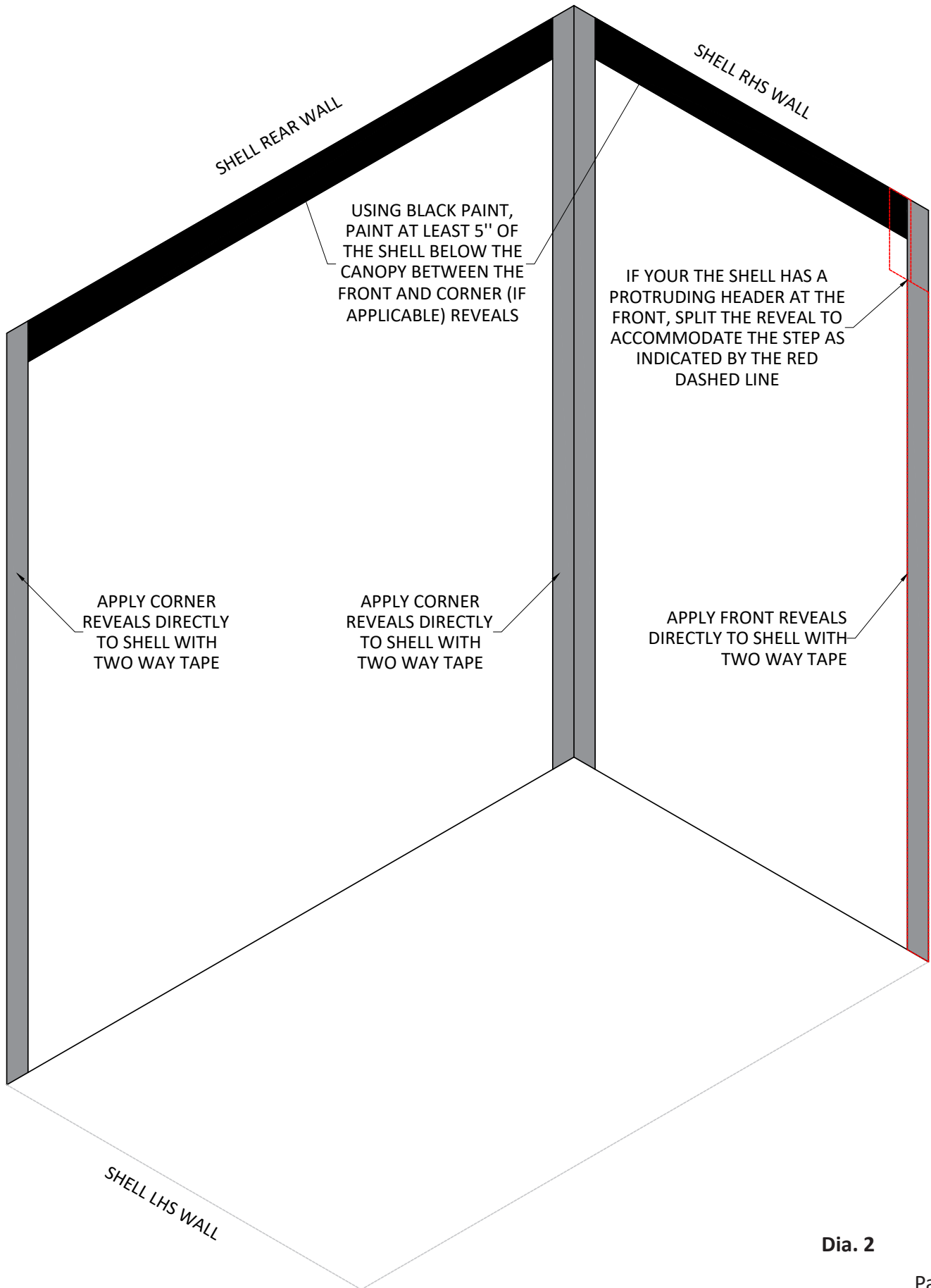

SECTION 4: INSTALL A-LOOK PANEL SYSTEM

- 4.1. Measure the width of each wall and determine the center point. Mark a line vertically at this point (Dia. 3).
- 4.2. Removable vented kick plates are provided with a centering notch; locate this notch and align it with the center of the shell.

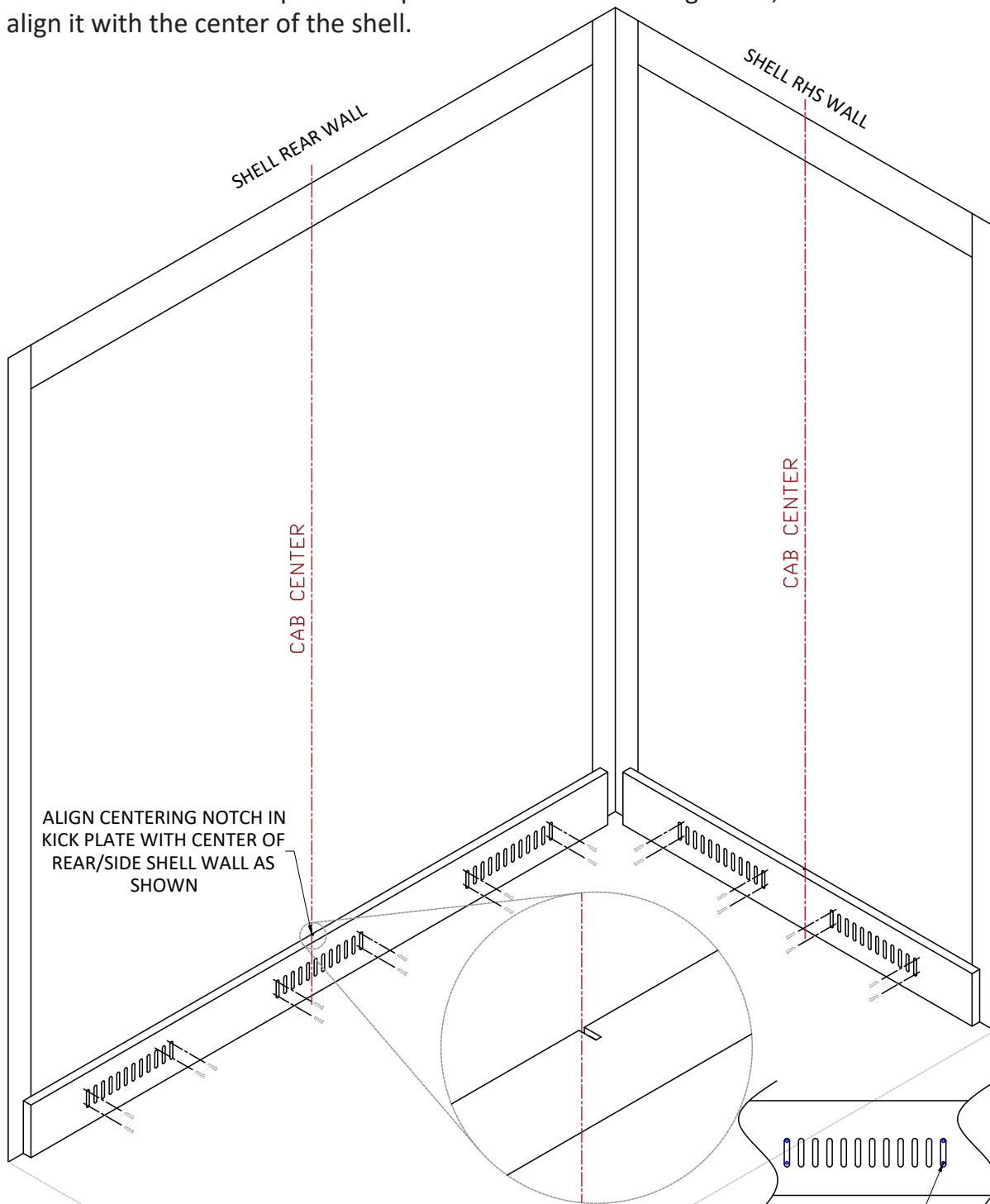

Note: The bottom of the kick plate should sit on or slightly above the finished floor. If no floor currently exists, simulate the finished floor height with an appropriate build out or shims before installing kick plates.

KICK PLATE IS SECURED TO SHELL WITH FASTENERS AS SHOWN; LOCATE FASTENER HOLES IN VENTS, TIGHTEN FASTENERS UNTIL KICK PLATE RESTS FIRMLY AGAINST SHELL

Dia. 3

SECTION 4: INSTALL A-LOOK PANEL SYSTEM (CONTINUED)

- 4.3. Center the kick plate on the back wall and fasten the kick plate to the wall using the mounting holes located inside the vent slots with tap screws provided (Dia. 3).



Note: At this point it is crucial to check that kick plates are square to adjacent walls and ensure that all kick plates are the same height on all three non-access walls before installing the panels.



Note: It is important to remove the protective plastic from the back, top and bottom of the kick plates prior to installation. Once installation is complete, these areas are no longer accessible.

- 4.4. If additional vent holes are required, refer to the included **Universal Baffle Strip Installation Manual** for more information and instructions on how to create additional ventilation in the cab shell.

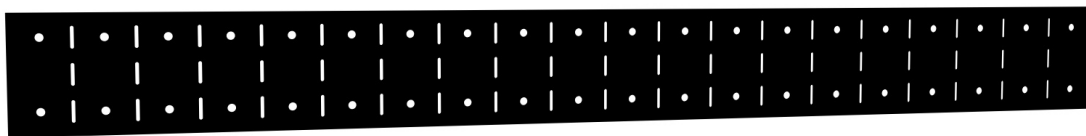

Dia. 4
Universal baffle strip.

- 4.5. Install the half panel interlock That is used as the starter strip. It will be pre-drilled with mounting holes. Place it centered on top of the kick plate. The “half extrusion” will be 1/8” shorter than the kick plate on each end. Repeat these steps for the side wall kick plates (Dia. 5).
- 4.6. Insert panel edges so that the 1/8” rounded edge faces into the cab. The panel edges should sit on top of the vented removable kick plate and tight to the half panel interlock. Screw or rivet the panel edge immediately above interlock to the wall. Repeat at the other end of the kick plate (Dia. 5).



Note: In high use cabs apply additional rivets to secure the panel edge to the cab shell. These additional fasteners help the panel edge to remain in place should they be subjected to impact or misuse.



Note: The panel interlocks are not attached to the panels. The interlocks are designed to be removed should the panels need to be reversed.



Warning: Do not lift the panels by the panel interlocks.

SECTION 4: INSTALL A-LOOK PANEL SYSTEM (CONTINUED)

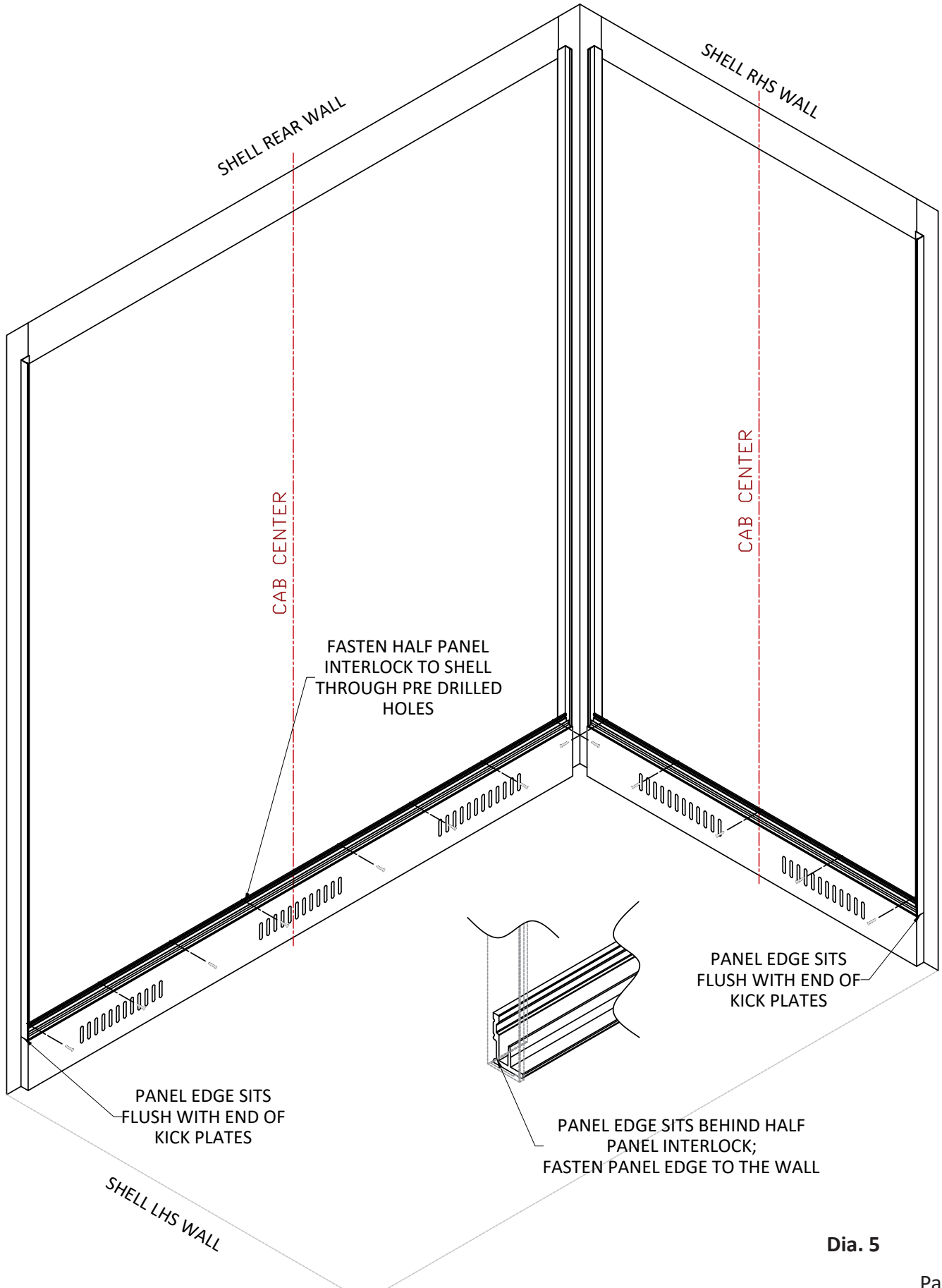

SECTION 4: INSTALL A-LOOK PANEL SYSTEM (CONTINUED)

- 4.7. Locate the next panel to be installed (bottom panels).
- 4.8. Insert panel into half panel interlock and fasten panel to the shell wall using center screw holes in panel interlock. Ensure the panel edge sits tight to the ends of the panels and fasten to the shell above the interlock. Finish fastening panel interlock through the holes provided (Dia. 6).



Warning: Do not lift the panels by the extrusions.

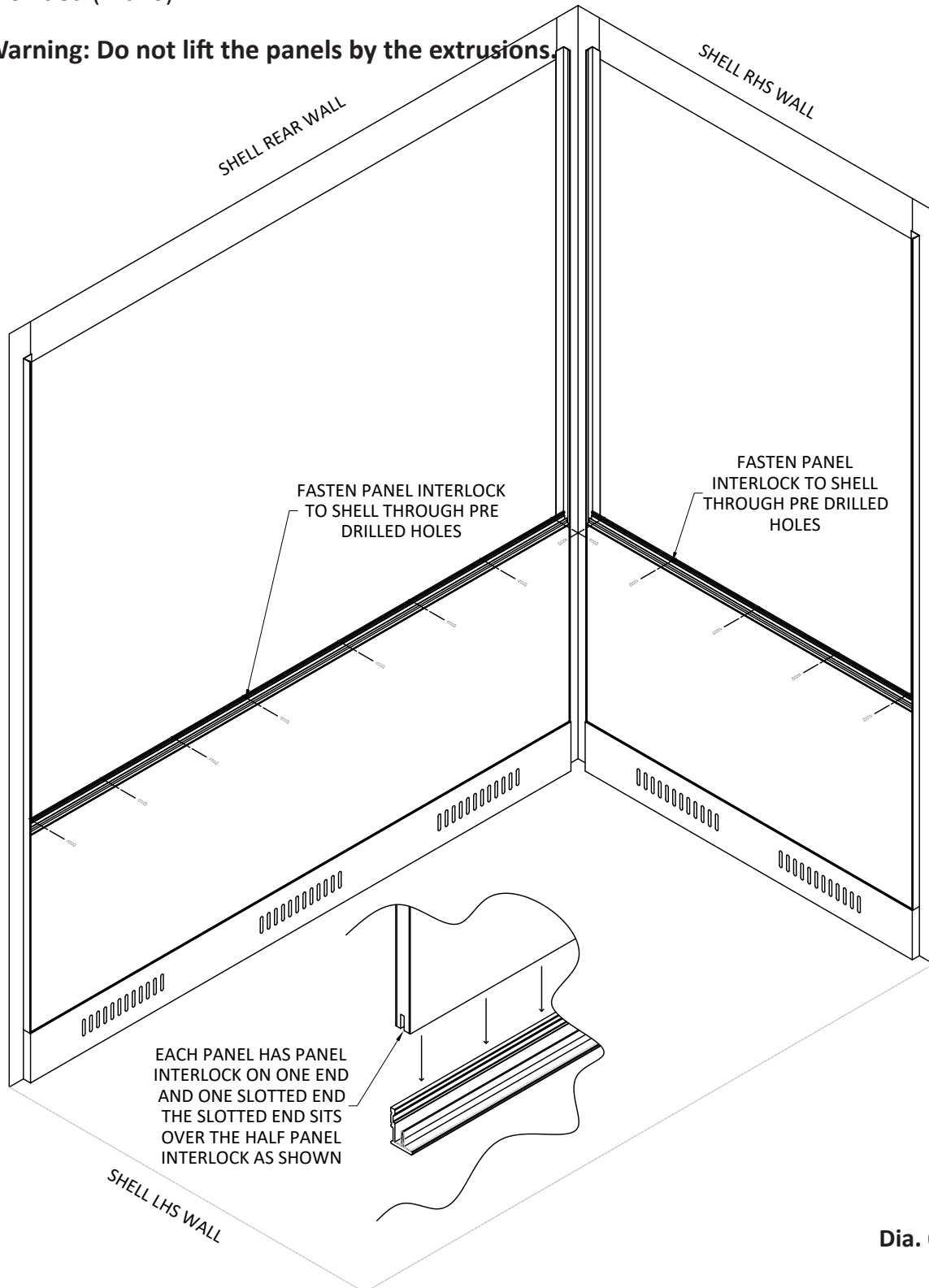

SECTION 5: INSTALL HANDRAILS

- 5.1. Temporarily install the handrail panel to transfer the hole locations to the cab shell (Dia. 7).
- 5.2. Remove the handrail panel and drill 1/2" holes into the cab shell as marked on the previous step.
- 5.3. Re-install the handrail panel (the holes should line up).

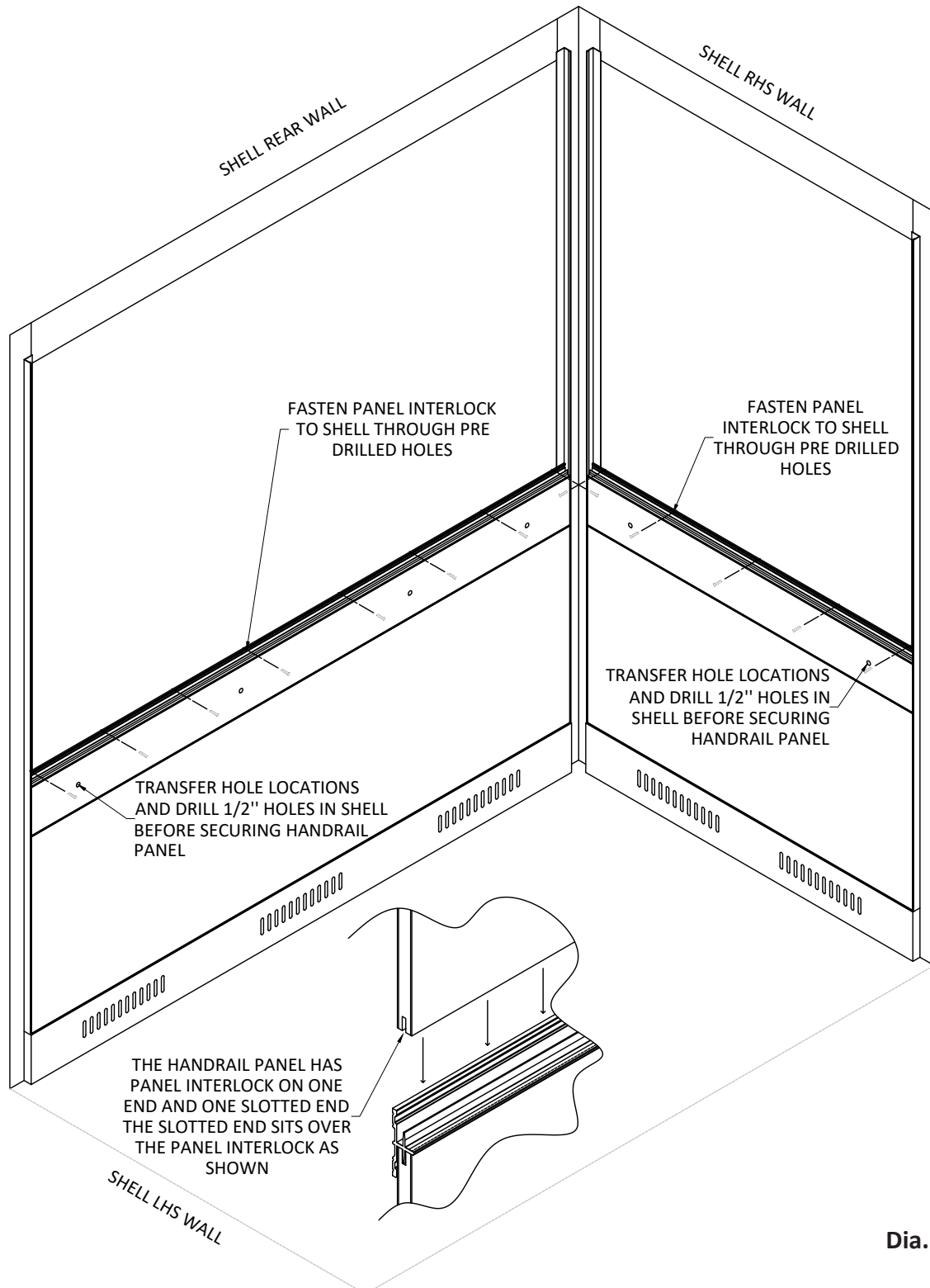

Dia. 7

SECTION 5: INSTALL HANDRAILS (CONTINUED)



Note: It is important to remove the protective plastic from the HMP prior to installation. Once the HMPs are installed the protective plastic is difficult to remove.

- 5.4. Insert and secure the provided togglers through the handrail panel and the shell.
- 5.5. Place the flared end of a stainless steel standoff against the handrail panel, centered on the toggler. Fasten this to the wall and handrail panel with the 1/4"-20 bolts provided.
- 5.6. Slide the inserts into the standoff (inserts are attached to the handrail).
- 5.7. Secure the handrail to the standoff using the set screws provided (Dia. 8).

Installing the Togglers

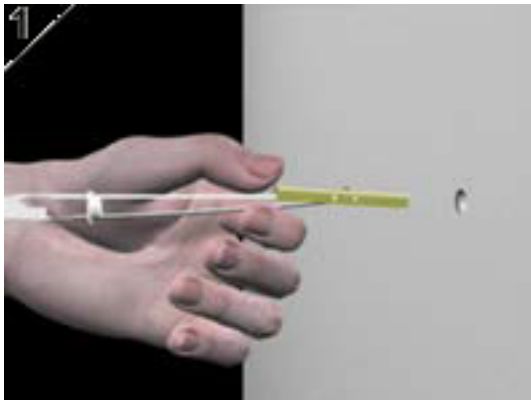

Drill a 1/2" hole. Hold the metal channel flat alongside plastic straps and slide channel through the metal channel through the hole. The minimum clearance behind the wall is 1 7/8".

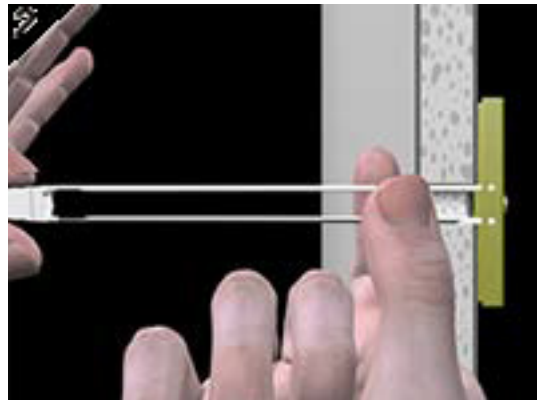

Hold the ends of straps between thumb and forefinger and pull toward you until channel rests flush behind wall. Slide plastic cap along straps with other hand until flange of cap is flush with the wall.

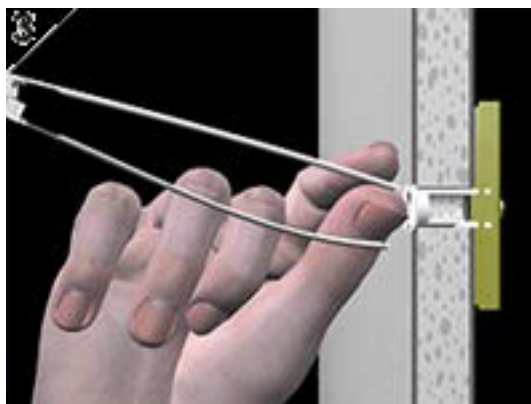

Snap straps at wall by pushing side to side snapping off straps level with flange cap.

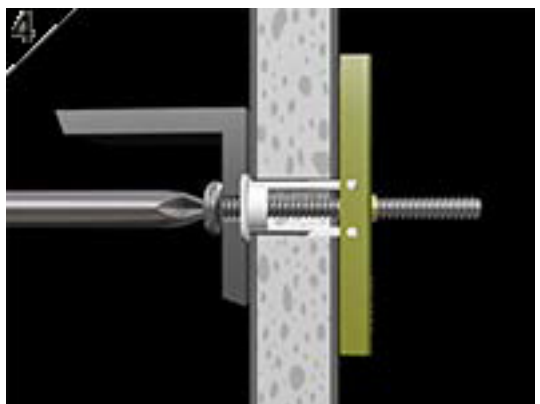

Place item over flange. Insert bolt through item and tighten until flush against item.

SECTION 5: INSTALL HANDRAILS (CONTINUED)

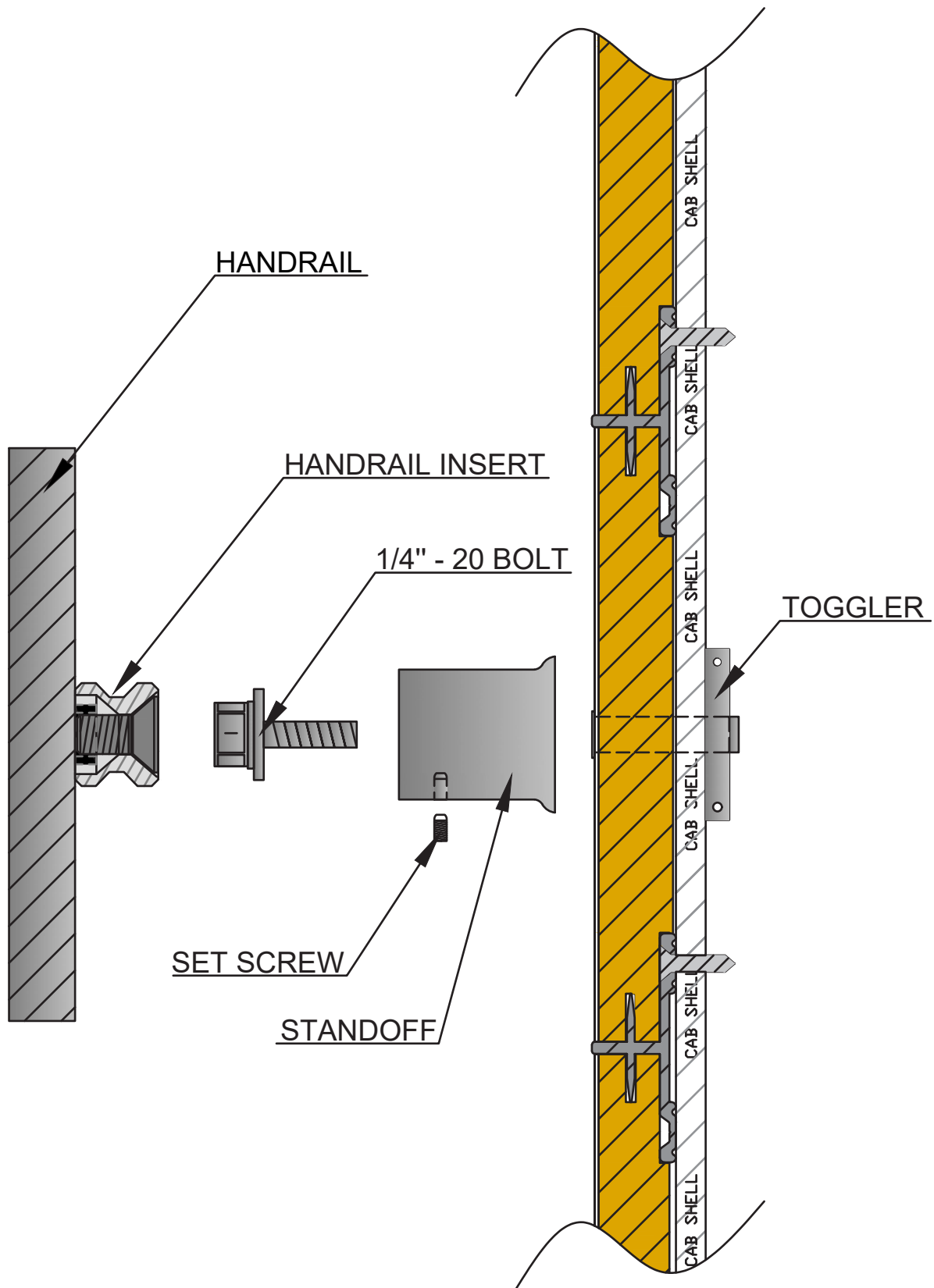

Dia. 8
Attaching standoffs to handrail.

SECTION 6: FINISHING A-LOOK PANEL SYSTEM

- 6.1. Install the three panels above the handrail panel following the same process as before. Insert the slotted side into the panel interlock and secure the attached extrusion to the shell with fasteners. Ensure the panel edge fits tightly against the edges of the panels (Dia. 9 through 11).

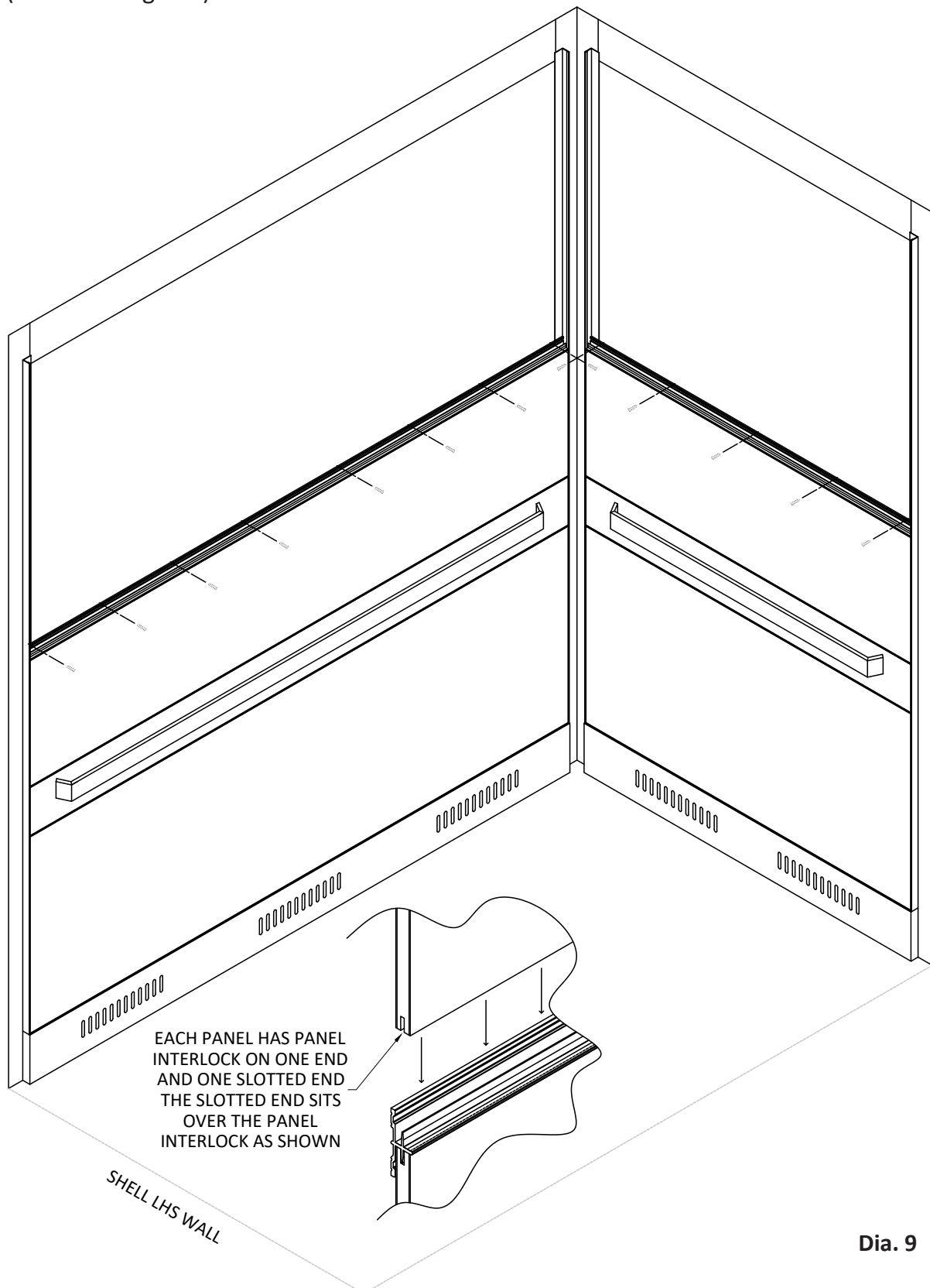

Dia. 9

SECTION 6: FINISHING A-LOOK PANEL SYSTEM (CONTINUED)

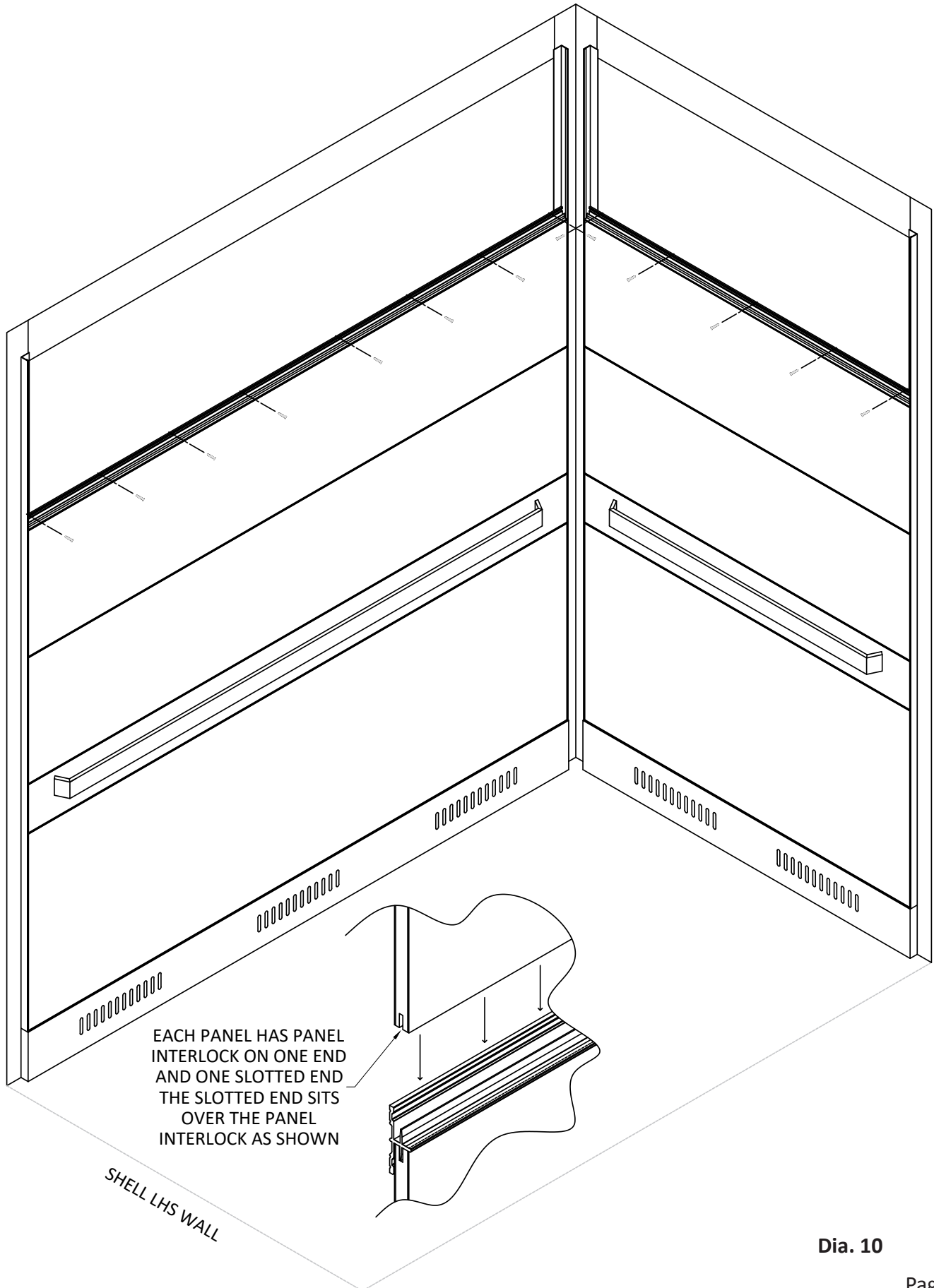

Dia. 10

SECTION 6: FINISHING A-LOOK PANEL SYSTEM (CONTINUED)

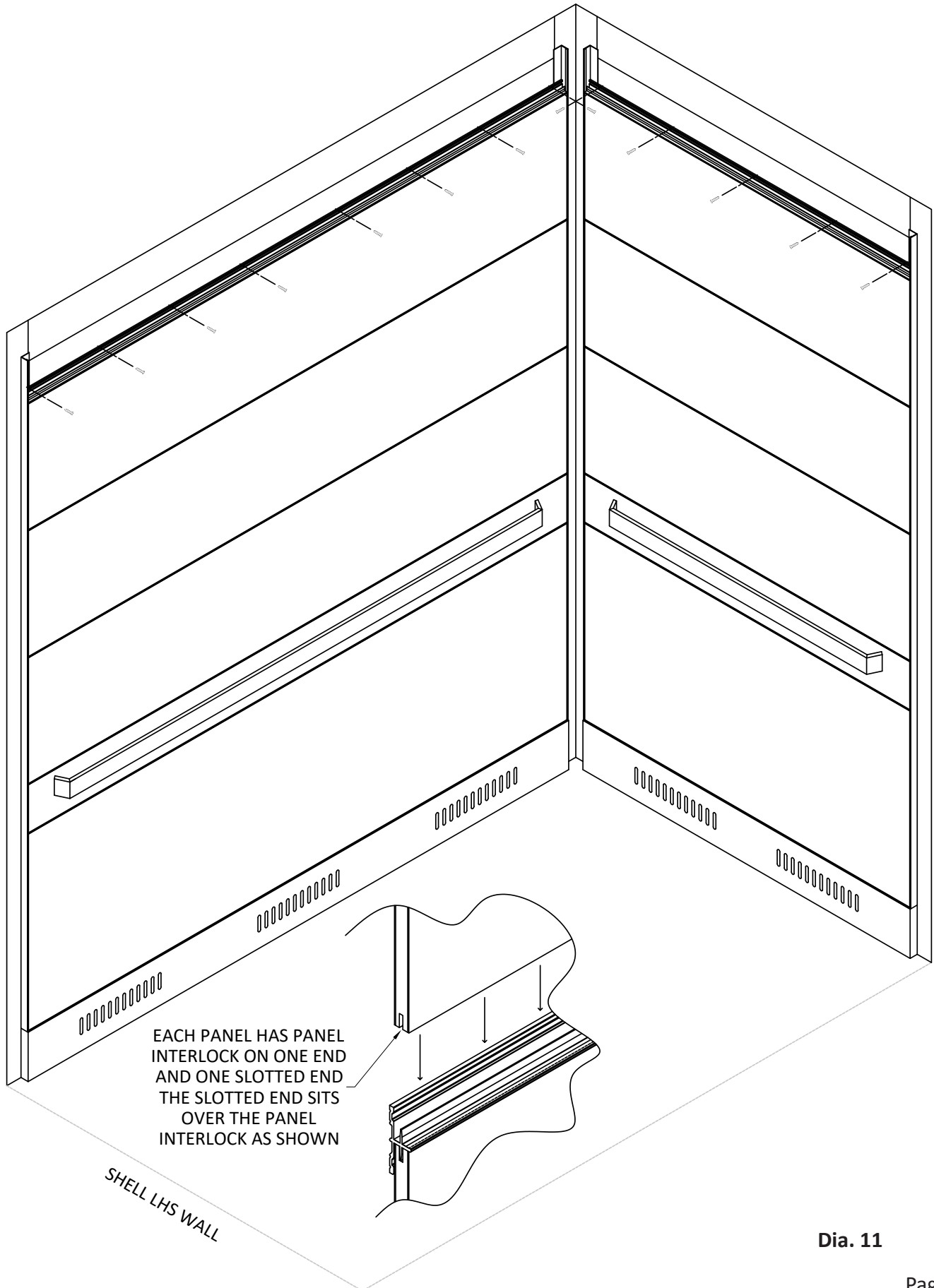

Dia. 11

SECTION 7: INSTALL TOP CAP PANELS

- 7.1. Before installing the top cap ensure the area above the wall finishes has been appropriately addressed (refer to section 3). Leave the plastic covering on the front face to protect the surface during the installation.
- 7.2. Sit the top cap onto the panel interlock, between the panel edges. Drill through the holes in tabs with a 1/8" drill bit into the cab shell. Secure the top cap to the wall using the pan head screws provided. A minimum of 4 screws should be utilized (Dia. 12).

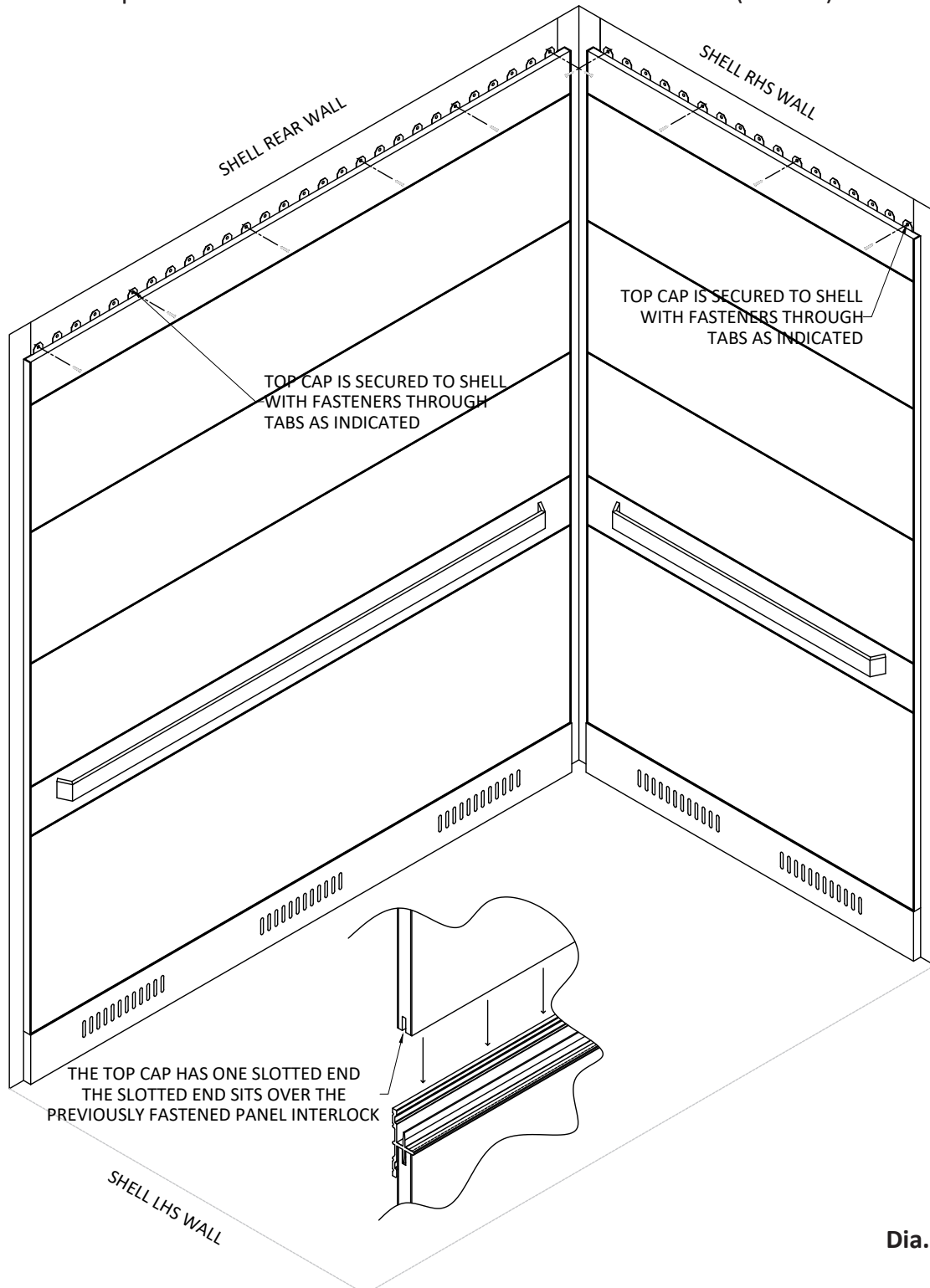

Dia. 12

SECTION 7: INSTALL TOP CAP PANELS (CONTINUED)

- 7.3. If removable pad hooks were purchased, you can now install them by inserting the hook into one of the slots located along the top of the top cap. If button pad hooks were selected, you can install them now (Dia. 13).



Note: Refer to the drawings for the pad hook install height. Protective pads are ordered to fit the installed height of the cab pins.

- 7.4. Remove the plastic covering from all metal panels once install is complete.

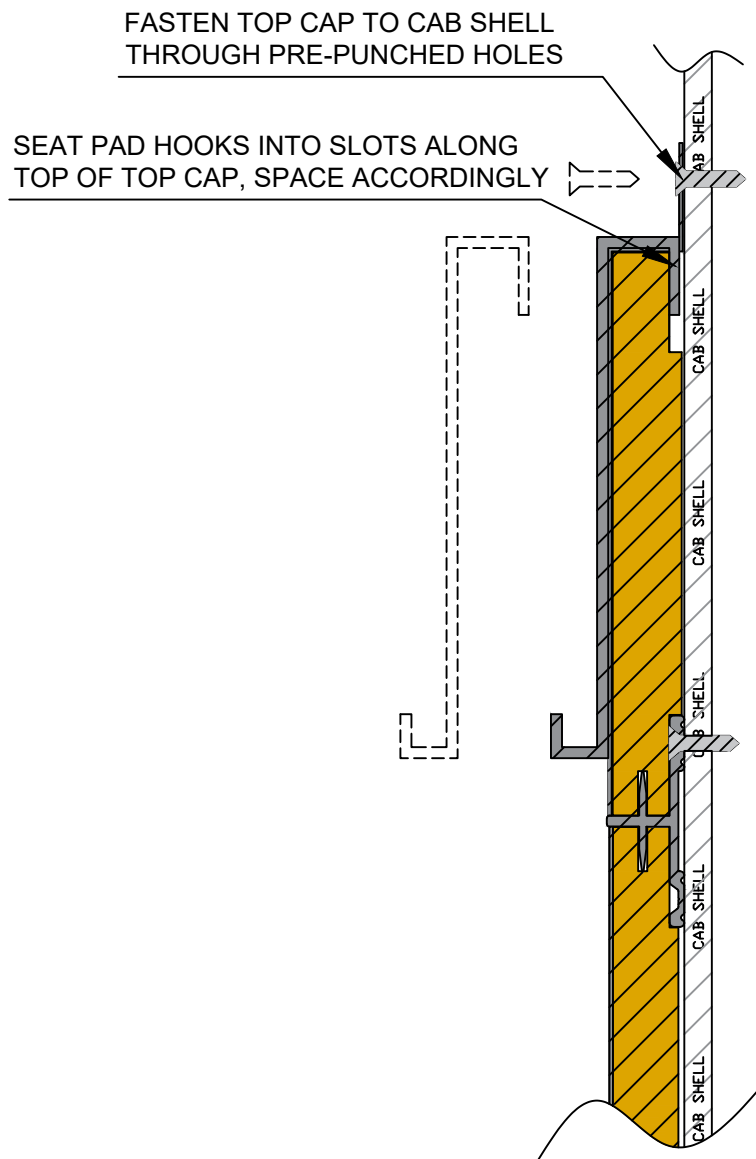

Dia. 13
Top cap detail.

SECTION 8: INSTALL ALTERNATE TOP CAP

- 8.1. If your A-look cab has an exposed top cap (typically required in cabs with low profile ceiling or raised crowns), your top cap will come with a pre-applied half extrusion to finish off the top edge of the panel.



Note: The top cap is applied to the shell with a small amount of silicon adhesive. Continue to the next page for instructions and typical silicon application.

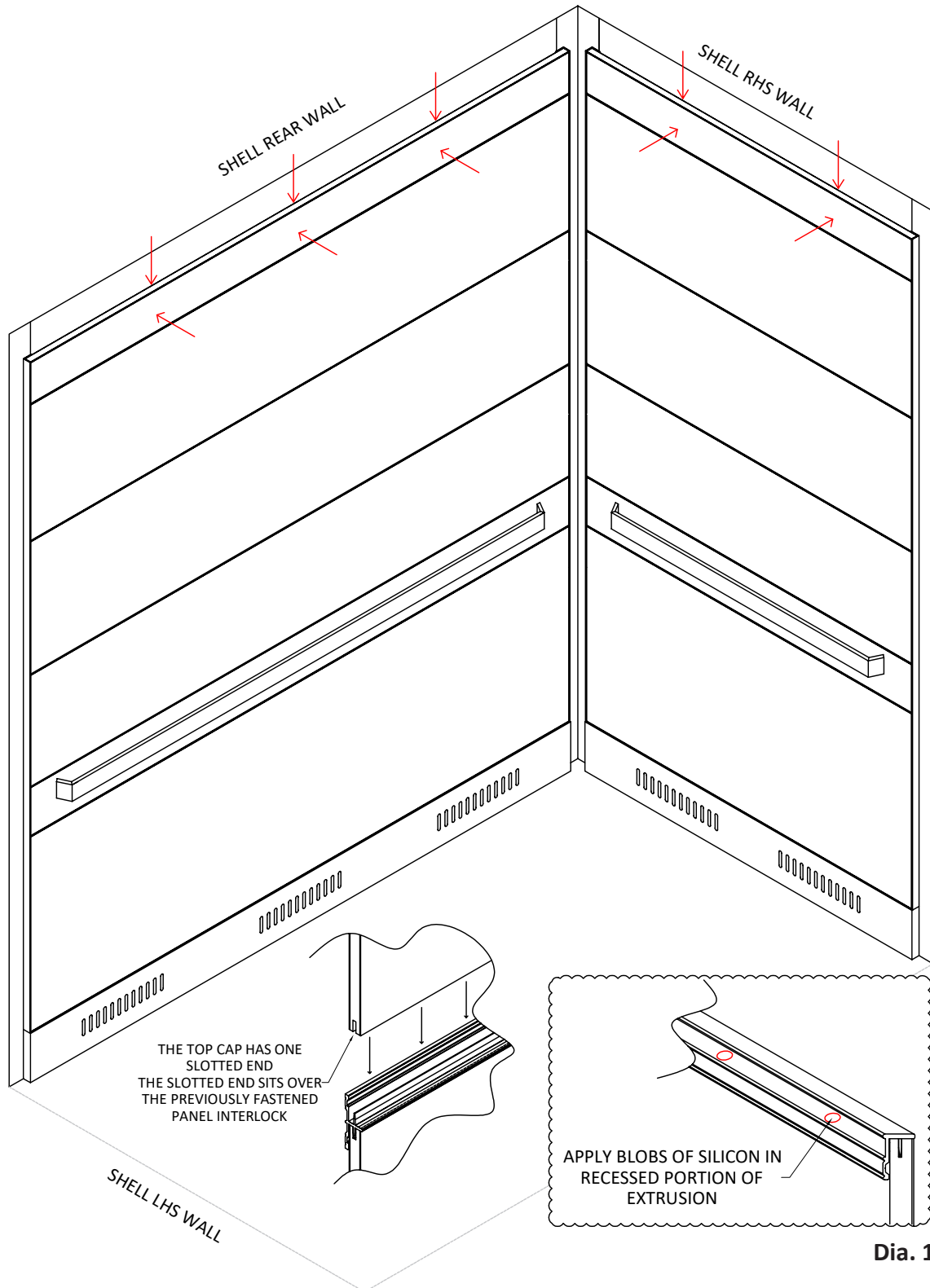

Dia. 14

SECTION 8: INSTALL ALTERNATE TOP CAP (CONTINUED)



Note: Do not over apply the silicon. There should be enough to hold the top cap in position but remain removable should the panels below require reversing or replacement.

- 8.2. Apply three to four 1/4" dia. sized blobs on the back of the extrusion groove for the side walls, five to six for the rear walls. Seat the groove of the top cap onto the extrusion and carefully lower the top cap into place.
- 8.3. Push the top cap against the shell wall to ensure the silicon adheres and holds the top cap in place.

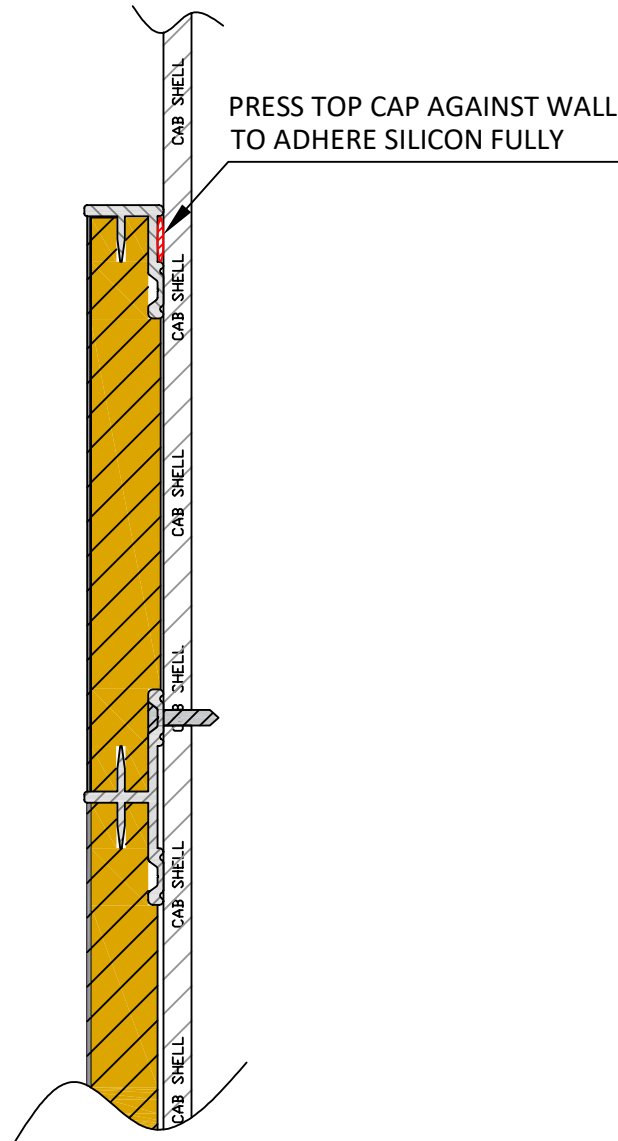

Dia. 15

Top cap detail (no drop ceiling).

- 8.4. Remove the plastic covering from all metal panels once install is complete.

GLOSSARY

Canopy:

The roof of the cab.

The top structural component of the shell.

The canopy houses the emergency hatch.

The canopy may have various electrical and mechanical components attached to its surfaces, both interior and exterior.

Non-Access Walls:

Any elevator cab wall which does not have an entrance.

“Panel Edge”:

A decorative component of the A-Look™ Horizontal Panel System.

The Panel edge is an aluminum extruded angle used to cover the outer edges of the horizontal panels.

“Panel Interlock” (patented):

A structural and decorative component of the A-Look™ Horizontal Panel System.

The “panel interlock” is an aluminum extrusion which allows one panel to be joined to another as well as to be fastened to the cab wall.

This extrusion also provides a decorative accent line at the panel junction.

Return Panel:

The wall of the cab adjacent to the entrance.

The return panel may contain the control panel, phone box and/or service panel.

The car door will slide behind the return panel.

Reveals:

Area of the elevator cab walls not covered by the panels.

This area is usually covered with stainless steel or plastic laminate.

Strike Post or Slam Post:

Part of the door frame on which the door closes.

For technical support on the A-Look Panel installation, please contact us at:

Elevator Cab Renovations

Office: (613) 745-4870

Toll Free: 1-877-745-4870

ecr@elevatorcabs.ca

Office Hours : 6:30 AM to 3:30 PM Eastern Standard Time



UNIVERSAL BAFFLE STRIP

TO BE UTILIZED WHEN ADDING
VENTILATION SLOTS TO AN
EXISTING CAB

INSTALLATION INSTRUCTION

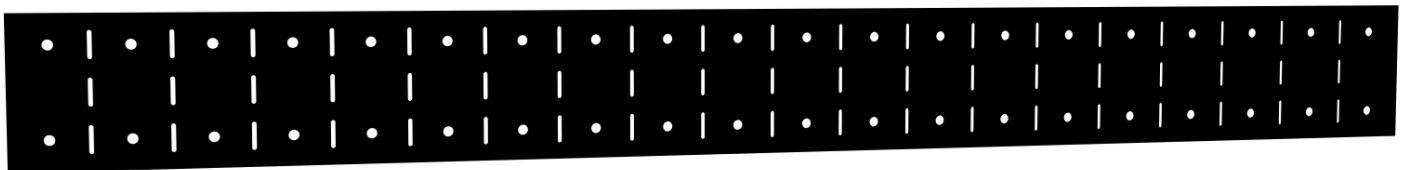

TOOLS REQUIRED

- Drill
- Jigsaw or Grinder
- Rivet Gun
- Rivets (max dia 3.2mm)
- or
- Screws (max dia 3.2mm)

CAB COMPONENTS TO BE INSTALLED

Universal Baffle Strip(s) to be cut to size to suit shell opening(s)

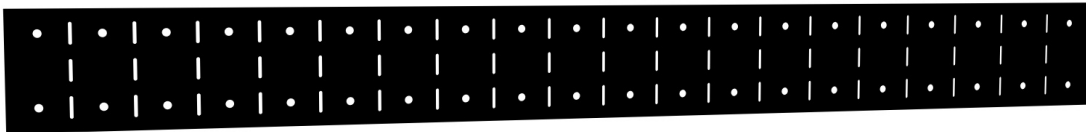

OVERVIEW

- 0.1. Included with your package is a universal baffle strip. The universal baffle strip is designed to be installed into open vent slots in the cab shell in order to prevent material passing through the vent slots into the hoist way (as per ASME-A-17.1/B-44). The universal baffle strip is intended to be installed from the cab shell interior, prior to the installation of the cab finishes. Please refer to the following instructions to properly install your universal baffle strip.

SECTION 1: PREPARE SITE FOR INSTALLATION

- 1.1. Once removal of the existing cab finishes are complete, determine if additional venting will be required.
- 1.2. If additional venting is required (as per ASME-A-17.1/B-44) locate and cut holes into the shell so that they will be hidden by the hollow vented kick plates (or hang on panels). Usually a 2'' (H) x 10'' (L) rectangular cut out is created off the finished floor for this purpose.
- 1.3. A typical side wall will have two cut-outs; a rear wall will have three cut outs.
- 1.4. Additional cut outs may also be required above the wall finishes close to the canopy (refer

SECTION 2: INSTALL UNIVERSAL BAFFLE STRIP

- 2.1. Begin by determining the span of the vent to be filled. The universal baffle strip is segmented; this allows the material to be bent inwards and outwards. Starting at one end, create a 90 degree bend in the strip followed by a 90 degree bend back (Dia .1).

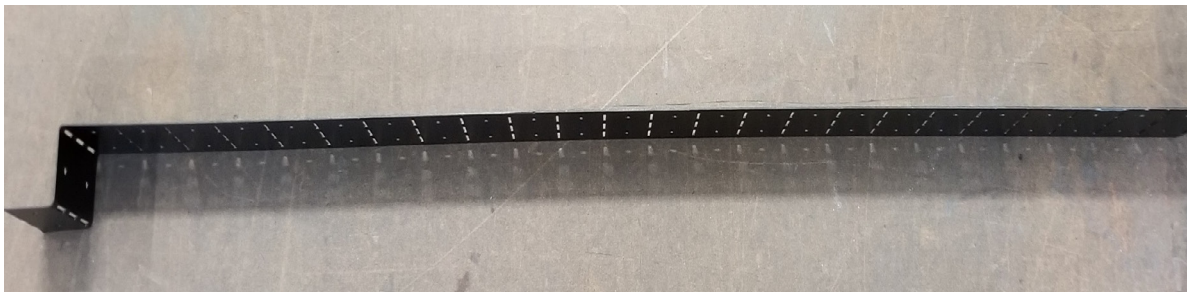

Dia. 1

Universal baffle strip, one end bent.

- 2.2. From this bend, follow the linkages until the span of the vent is reached (or as much as possible) and mirror the bends (Dia. 2). Use more or less linkages to suit the style and depth of the vent holes.

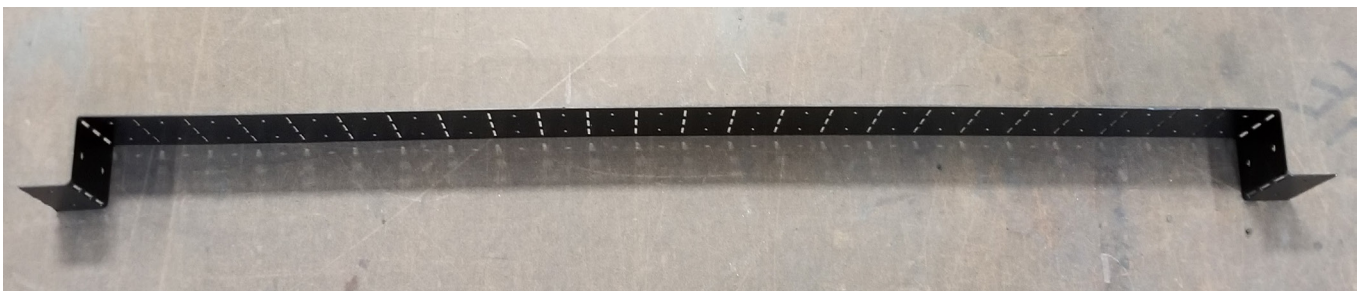

Dia. 2

Universal baffle strip, both ends bent, excess trimmed.

SECTION 2: INSTALL UNIVERSAL BAFFLE STRIP (CONTINUED)

- 2.3. Trim the excess material and retain the remainder of the baffle strip for additional vents if applicable.
- 2.4. Fit the baffle strip into the vent slot (Dia .3) and secure to the cab shell with screws or rivets (Dia .4).



Dia. 3
Universal baffle strip, ready for installation.

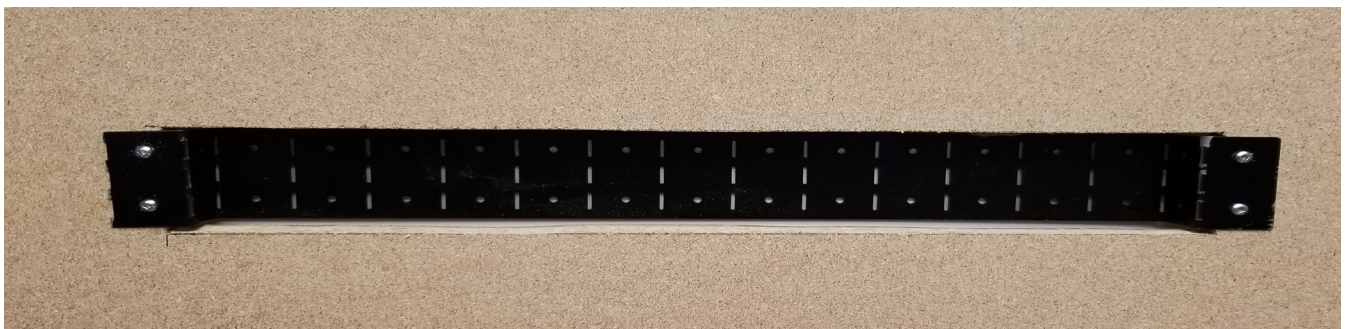

Dia. 4
Universal baffle strip installed, secured with fasteners.

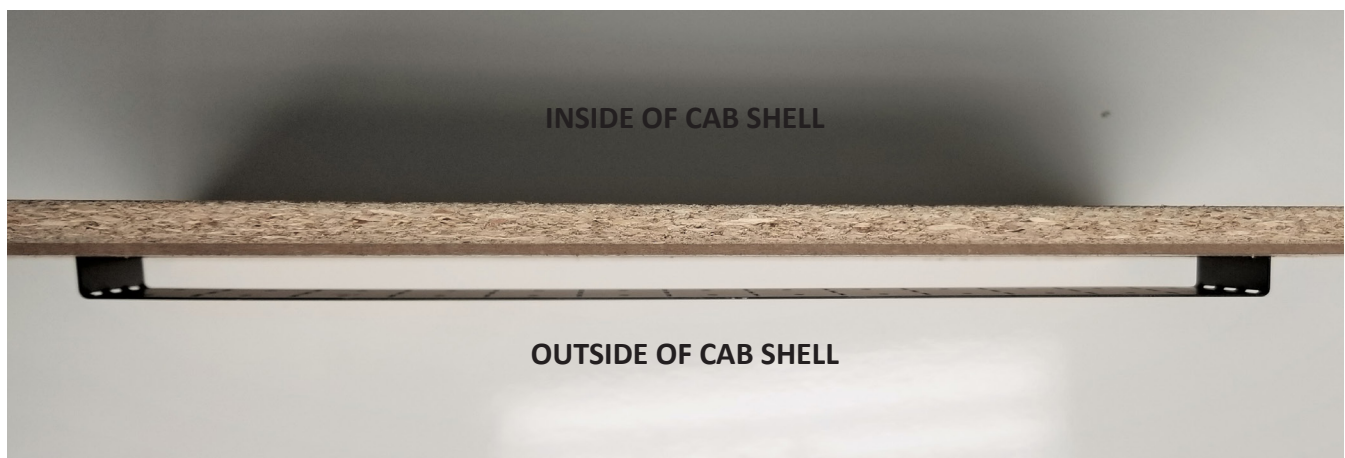

Dia. 5
Section view of universal baffle strip.

- 2.5. Once the vent slots and baffle strip are in place, proceed with installing the new cab finishes.