



B-Look™

PANEL FITMENT SYSTEM

MODEL:
EMPIRE STATE PLAZA
FRANKLIN SQUARE
HARVARD SQUARE
TRANQUILITY PARK

INSTALLATION INSTRUCTIONS



CAB COMPONENTS TO BE INSTALLED

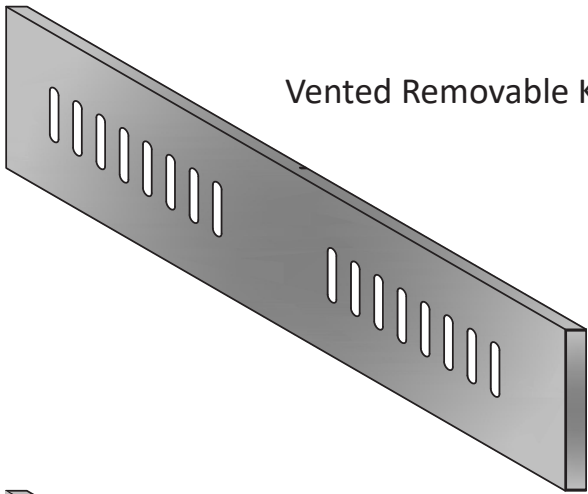

Vented Removable Kick Plate

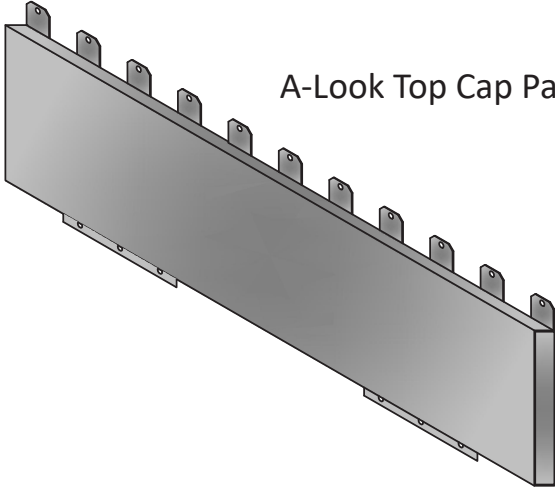

A-Look Top Cap Panel

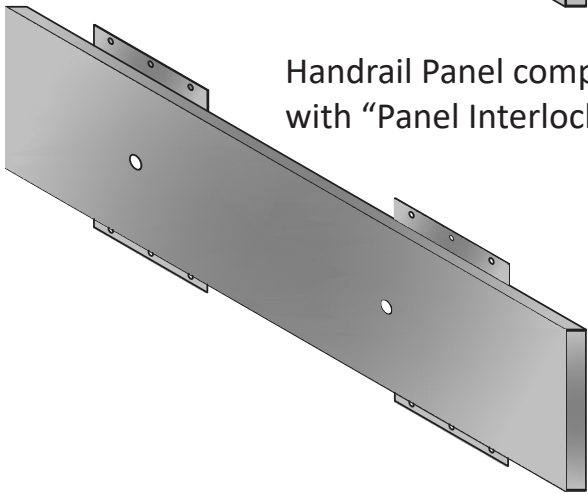

Handrail Panel complete with "Panel Interlock"

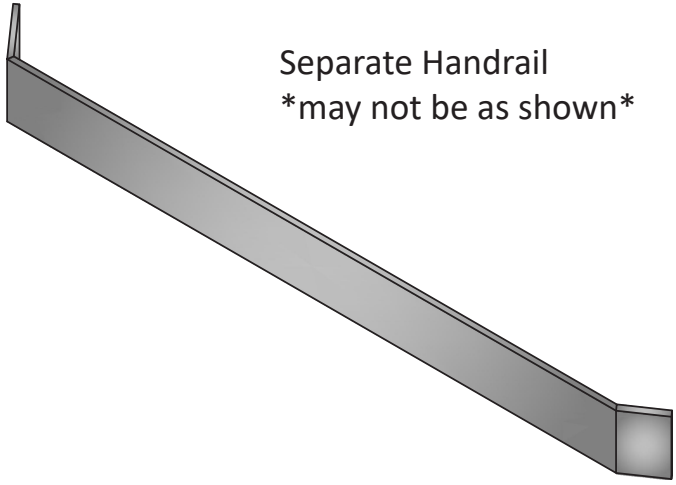

Separate Handrail
may not be as shown

Several panels complete with panel binders, laminate or black tape edges.

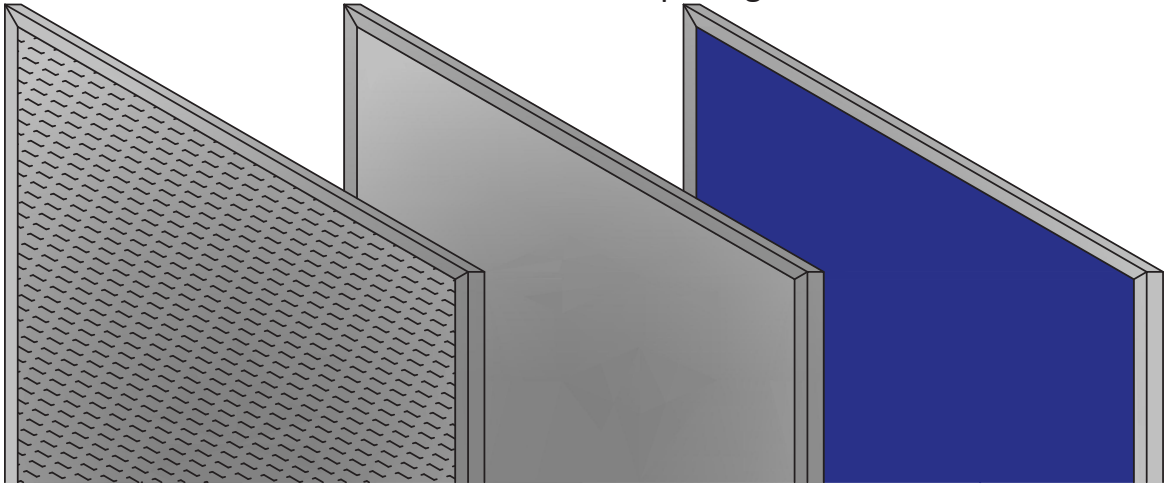

Pieces are pre-sized to fit their corresponding wall. All parts will be marked as illustrated in the Cab Component Labelling Diagram.

TOOLS REQUIRED

- Measuring Tape
- Drill
- Frame Square
- Ladder
- 2" or 3" Paint Brush for Latex Paint
- Rivet Gun

CAB COMPONENT LABELLING

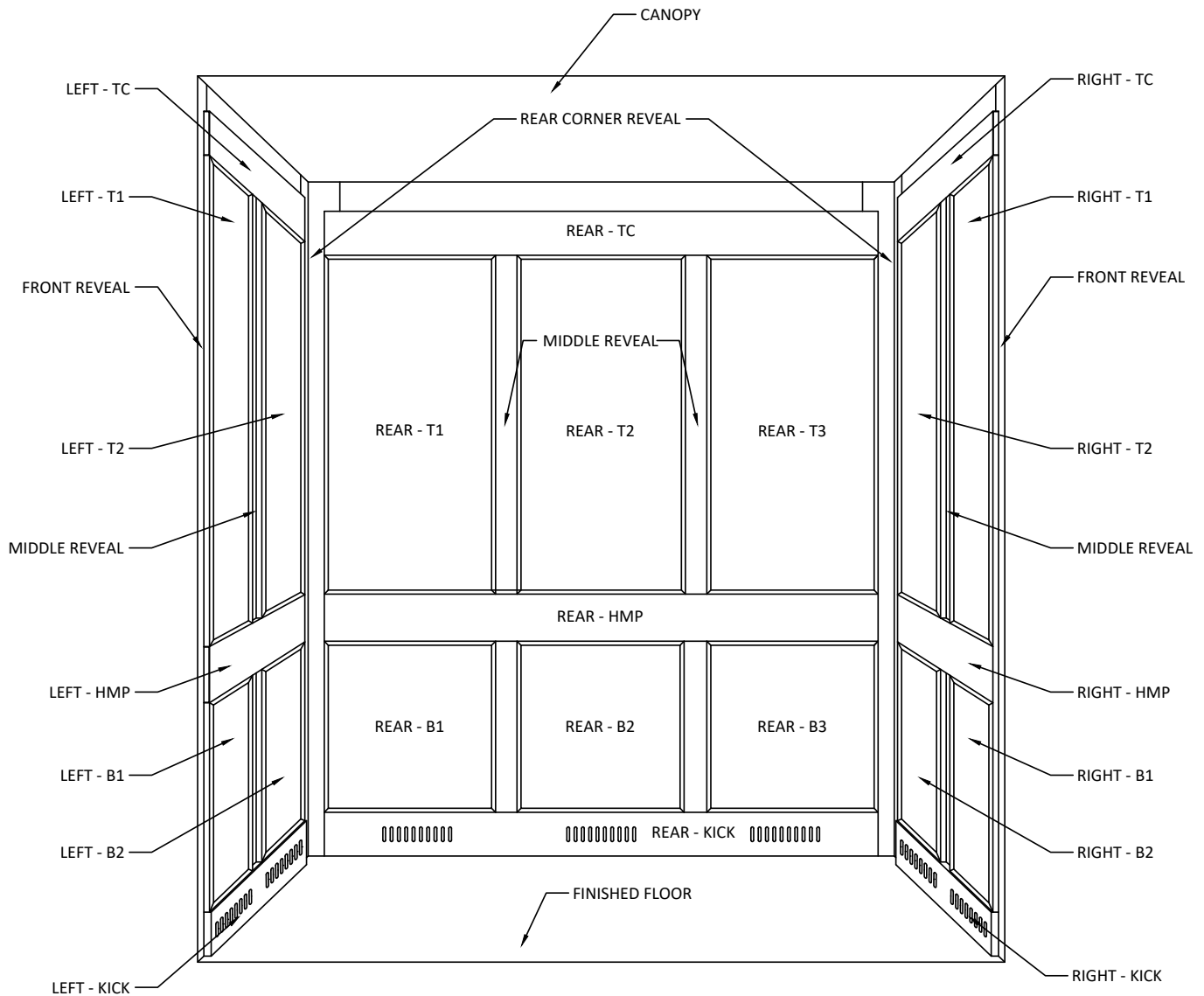

Dia. 1

SECTION 1: UNPACKING

- 1.1. When your new B-Look™ cab arrives, transport it near to the cab you will be renovating and organize the crates so that they will be easily accessible.

The crate's contents are itemized on its surface.

One box will be labelled "Open First". It contains the drawings, instructions, hardware & adhesive.

- 1.2. Carefully un-crate the cab package, making sure that none of the components are damaged.
- 1.3. Check the colours, features, and dimensions of the components against your order before you begin removing the existing elevator interior.
- 1.4. Note the labelling on the components on the previous page. The labels indicate the order in which the components will be installed and will help you identify the correct component called for in the instructions.

If you have any questions at this point, contact ECR before going ahead with any part of the installation.

For technical support on the B-Look Panel installation, please contact us at:

Elevator Cab Renovations
Office: (613) 745-4870
Toll Free: 1-877-745-4870
ecr@elevatorcabs.ca

Office Hours : 6:30 AM to 3:30 PM Eastern Standard Time

SECTION 2: PREPARE SITE FOR INSTALLATION

- 2.1. Remove all materials being replaced from the existing cab, stripping the cab down to the bare shell. Clean any debris and oil from the cab shell.
- 2.2. If the drop ceiling is being replaced, paint the perimeter of the canopy 4" in from all sides with matte black latex paint (paint is not included). The remainder of the canopy will not be visible once the new ceiling is installed.
- 2.3. If the floors are being replaced, remove existing floor and install new flooring before installing the A-Look panels. If the floors are not being replaced, use a protective covering to prevent damage to the floor.

SECTION 3: INSTALL CAB REVEALS

- 3.1. Dry fit the front reveals and trim reveals as necessary. Reveals can be up to 1/4" short of the canopy without affecting the final look of the cab (Dia. 2).
- 3.2. If your shell has a protruding header, split the reveal where the step occurs and fit the remaining reveal piece against the step as indicated by the red dashed line (Dia. 2).
- 3.3. Apply the supplied 2-sided tape to the back side of the reveals.
- 3.4. Starting at the bottom press the reveals onto the cab shell, ensuring a tight fit against the front and flush to the floor. Apply pressure to ensure the reveal adheres to the cab shell.
- 3.5. Fit and install the vertical reveals in their corresponding location according to the drawings. The reveals are cut 4" wide to provide a visible 2" reveal with 1" extra on each side under panels. The reveals are oversized so it is not necessary to install them perfectly centered (Dia. 2).
- 3.6. A drop ceiling will block the canopy from view; if your cab has a drop ceiling, or a drop ceiling was purchased, paint the shell walls below the canopy and between the reveals with matte black latex paint (not included). The top cap normally sits 4 inches below the canopy; paint at least 5 inches below the canopy (Dia. 2).
- 3.7. If the top cap will be visible, stainless steel horizontal reveals will be included. Fit the reveals tight against the canopy between the corners and front reveals, trimming if necessary. Apply the reveals to the shell with 2-sided tape.



Note: It is important to remove the protective plastic from the reveals before continuing the installation. Once the kick plates are installed the protective plastic is difficult to remove.



Note: The middle reveals extend past the Top Cap but will not touch the canopy. If your cab has an exposed Top Cap, the middle reveals must be trimmed (if necessary) to fit between the shell floor and the bottom of the horizontal reveals.

SECTION 3: INSTALL CAB REVEALS (CONTINUED)

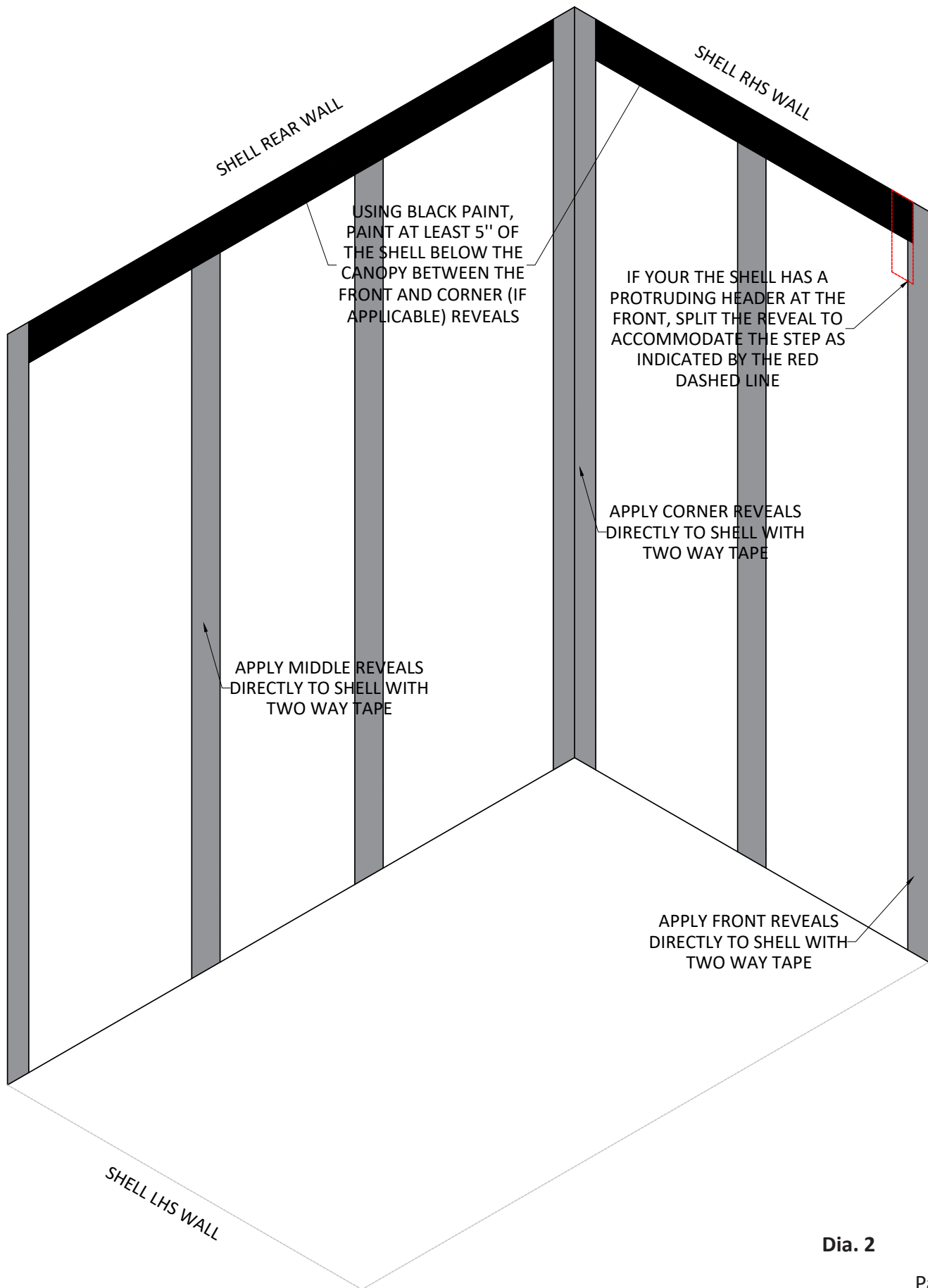

SECTION 4: INSTALL B-LOOK PANEL SYSTEM

- 4.1. Measure the width of each wall and determine the center point. Mark a line vertically at this point (Dia. 3).
- 4.2. Align the center of the kick plates with the previously marked center line.

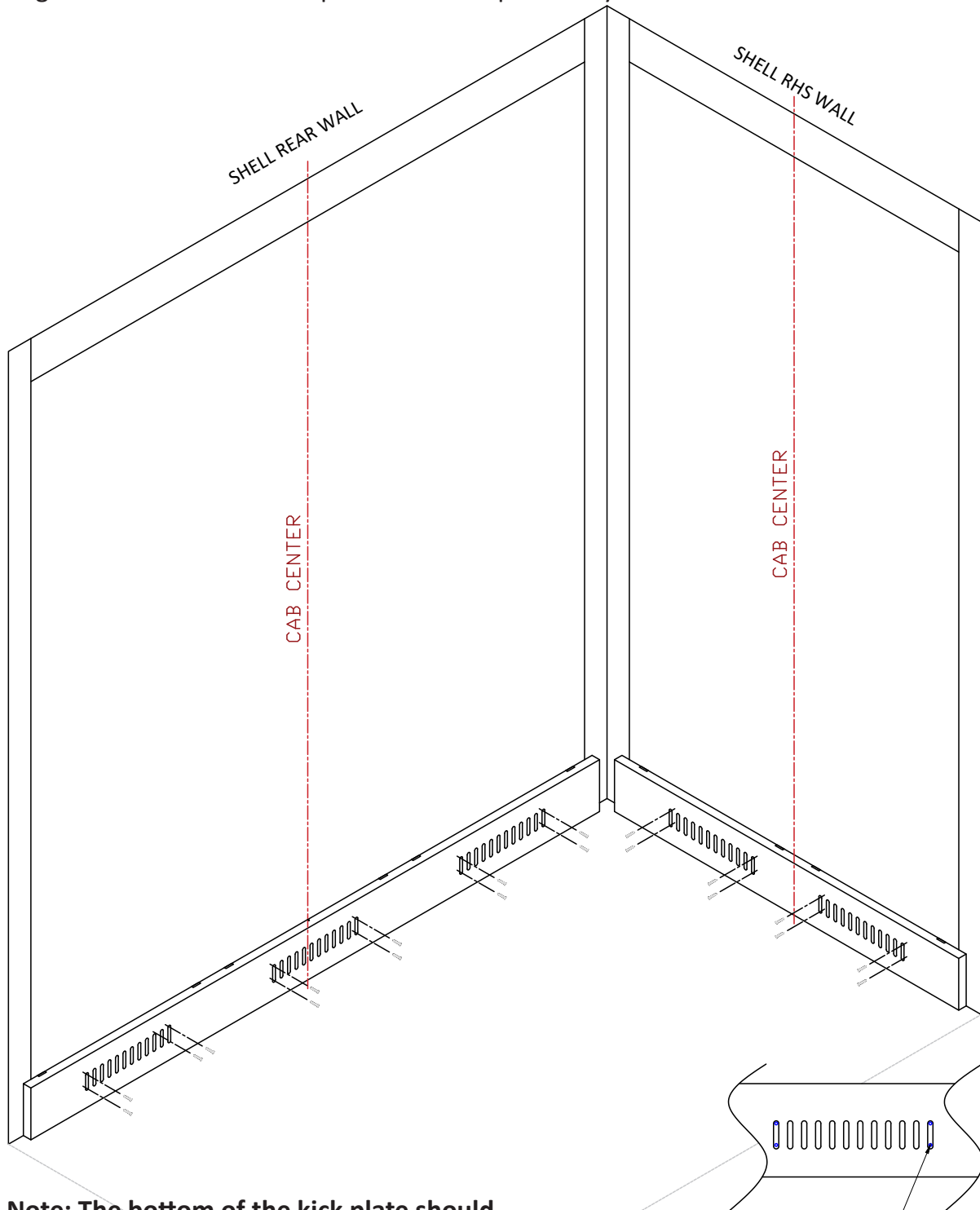

Note: The bottom of the kick plate should sit on or slightly above the finished floor. If no floor currently exists, simulate the finished floor height with an appropriate build out or shims before installing kick plates.

KICK PLATE IS SECURED TO SHELL WITH FASTENERS AS SHOWN; LOCATE FASTENER HOLES IN VENTS, TIGHTEN FASTENERS UNTIL KICK PLATE RESTS FIRMLY AGAINST SHELL

Dia. 3

SECTION 4: INSTALL B-LOOK PANEL SYSTEM (CONTINUED)

- 4.3. Fasten the kick plate to the wall using the mounting holes located inside the vent slots with tap screws provided (Dia. 3).



Note: At this point it is crucial to check that kick plates are square to adjacent walls and ensure that all kick plates are the same height on all three non-access walls before installing the panels.



Note: It is important to remove the protective plastic from the back, top and bottom of the kick plates prior to installation. Once installation is complete these areas are no longer accessible.

- 4.4. If additional vent holes are required, refer to the included **Universal Baffle Strip Installation Manual** for more information and instructions on how to create additional ventilation in the cab shell.

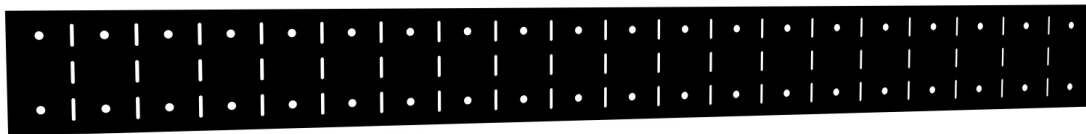

Dia. 4
Universal baffle strip.

- 4.5. Included with your B-Look cab is a z-clip template. The kick plates feature pre-punched slots that accept the bent tab on the end of the template. Place the left and right template (with openings facing towards each other) in the slots and hold it or secure it to the shell with temporary fasteners or masking tape (Dia. 5).
- 4.6. To install z-clips, sit them in the open windows and sit them flush with the bottom of the openings. Mechanically fasten the Z-Clip to the shell with the 1" tapping screws provided (Dia. 6).



Note: Ensure the z-clip is installed in the correct orientation.

SECTION 4: INSTALL B-LOOK PANEL SYSTEM (CONTINUED)

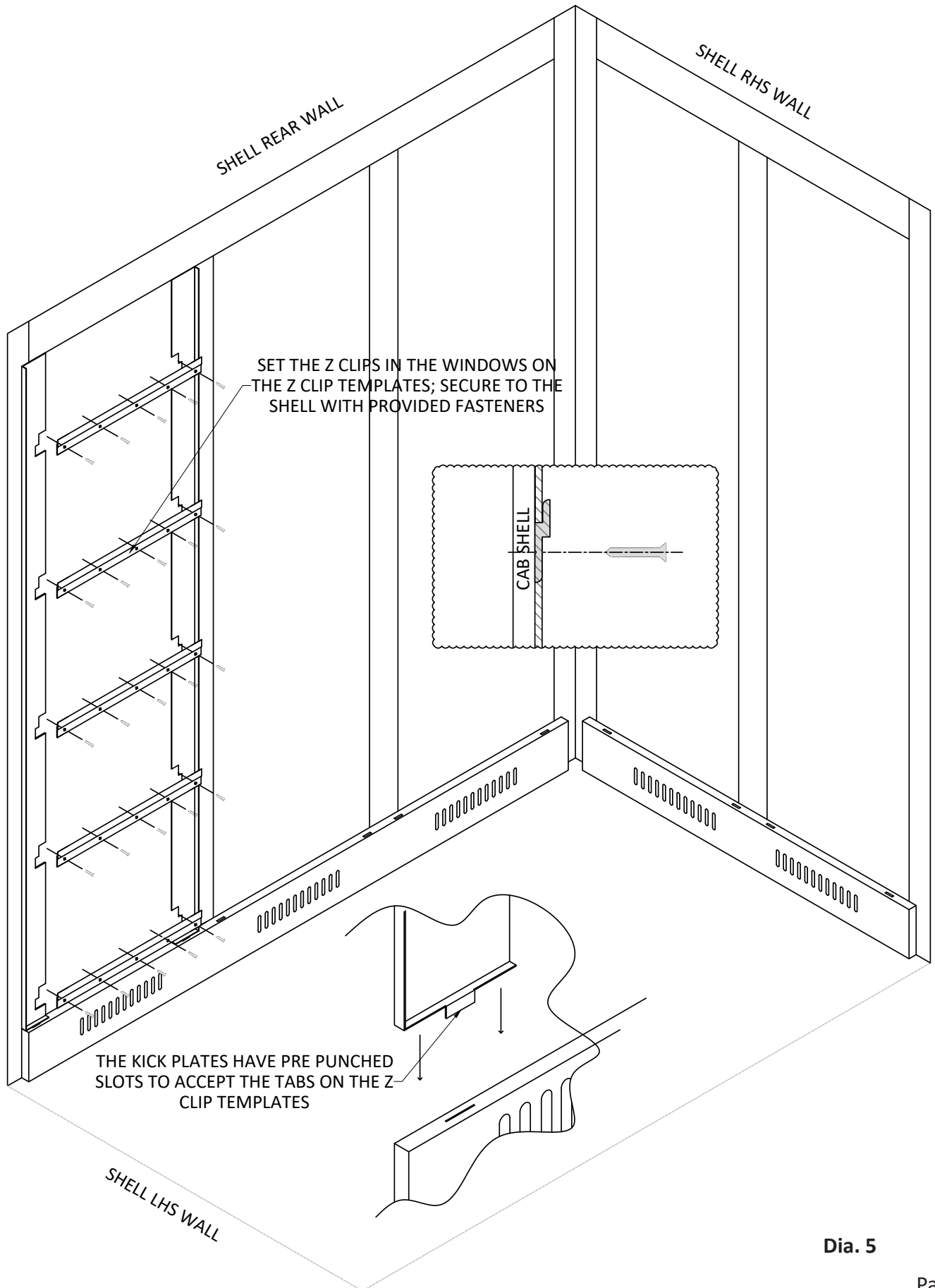

Dia. 5

SECTION 4: INSTALL B-LOOK PANEL SYSTEM (CONTINUED)

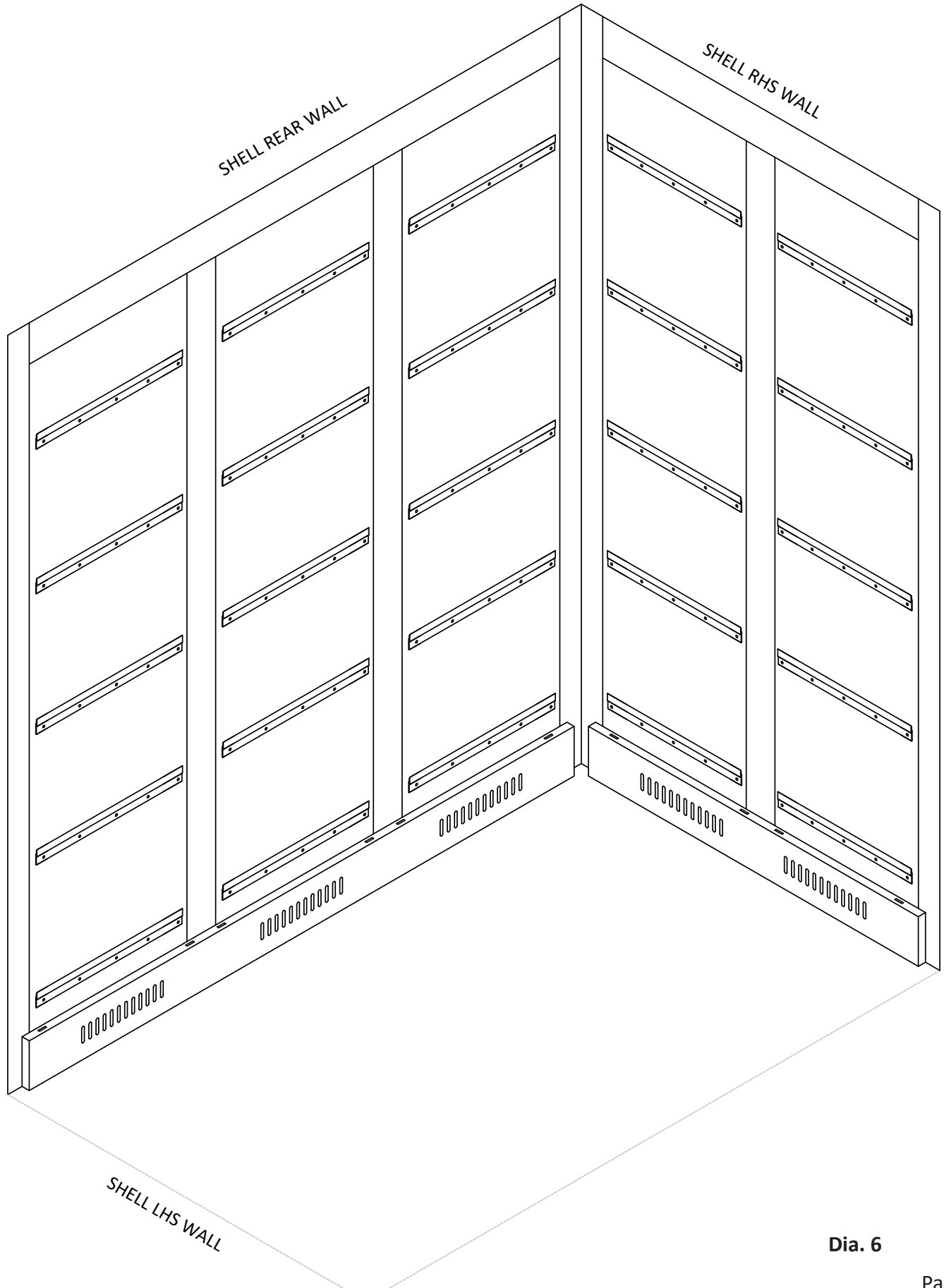

Dia. 6

SECTION 4: INSTALL A-LOOK PANEL SYSTEM (CONTINUED)

- 4.7. Once z-clips have been installed, space the lower panels on the walls and set them in place on the installed z-clips. The outer panels should sit flush with the kick plates with 2" reveals between panels (Dia. 7).

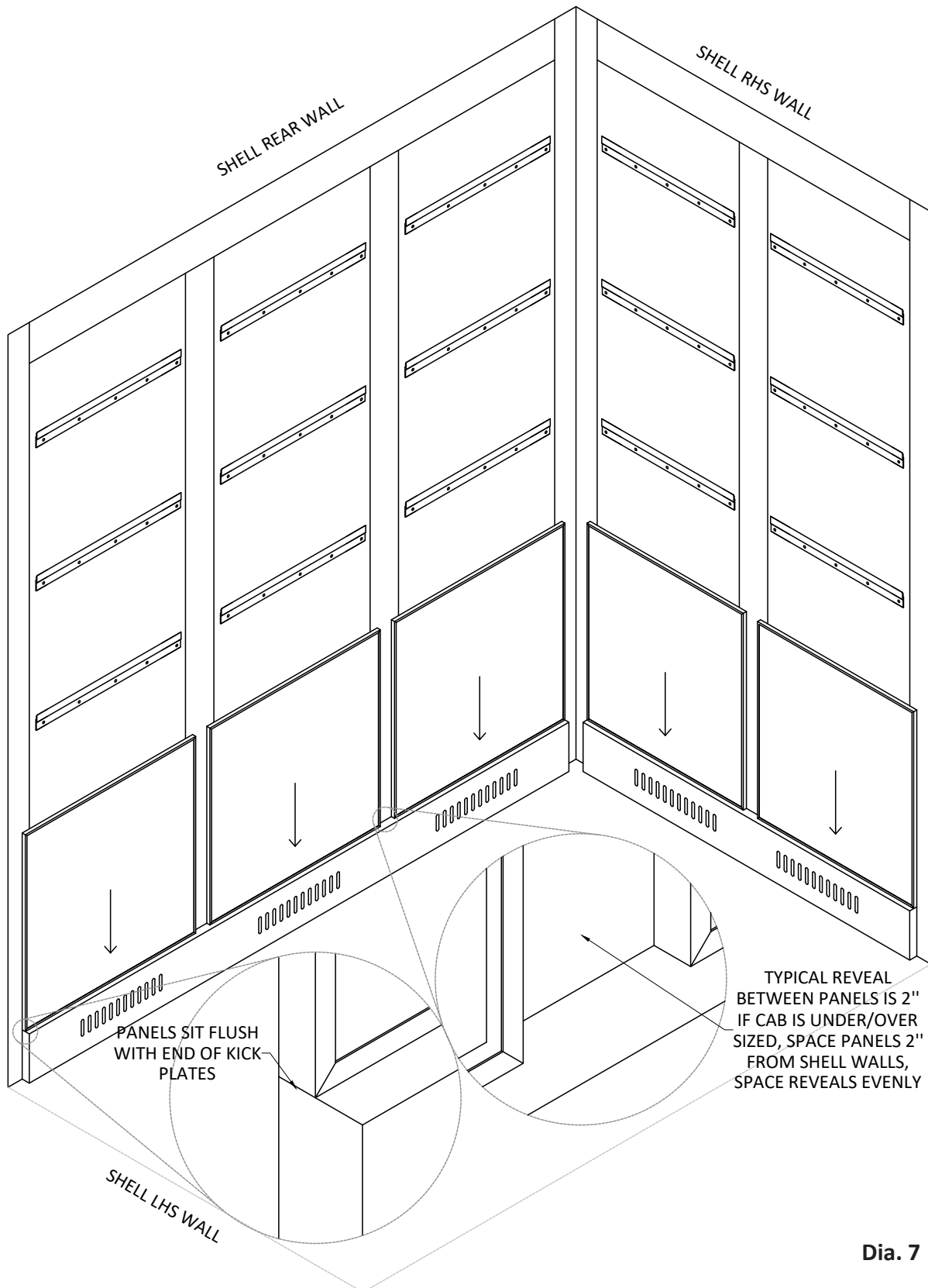

Dia. 7

SECTION 4: INSTALL A-LOOK PANEL SYSTEM (CONTINUED)

- 4.8. Install the Handrail Mounting Panel by setting the tabs behind the previously applied panels; secure the panel in place by fastening the tabs above the panel through the shell.

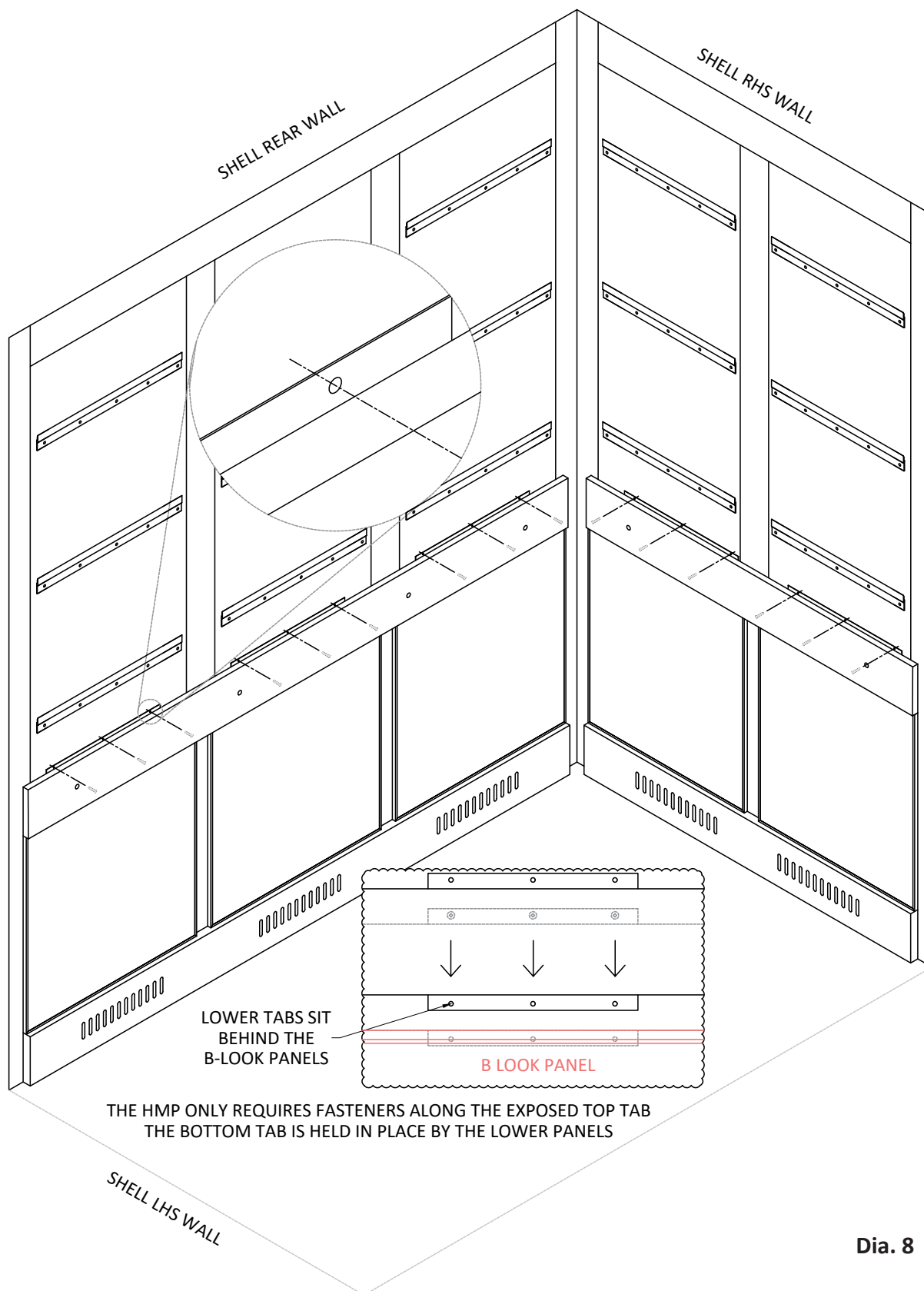

Dia. 8

SECTION 5: INSTALL HANDRAILS

- 5.1. Locate the pre-punched standoff locations in the HMP.
- 5.2. Drill 1/2" holes through the pre-punched holes through the substrate, through the cab shell.



Note: It is important to remove the protective plastic from the HMP prior to installation. Once the HMPs are installed the protective plastic is difficult to remove.

- 5.3. Insert and secure the provided togglers through the HMP and the shell.
- 5.4. Place the flared end of a stainless steel standoff against the handrail panel, centered on the toggler. Fasten this to the wall and handrail panel with the 1/4"-20 bolts provided.
- 5.5. Slide the inserts into the standoff (inserts are attached to the handrail).
- 5.6. Secure the handrail to the standoff using the set screws provided (Dia. 9).

Installing the Togglers

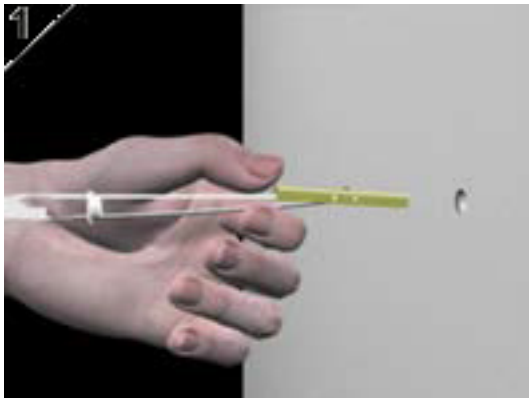

Drill a 1/2" hole. Hold the metal channel flat alongside plastic straps and slide channel through the metal channel through the hole. The minimum clearance behind the wall is 1 7/8".

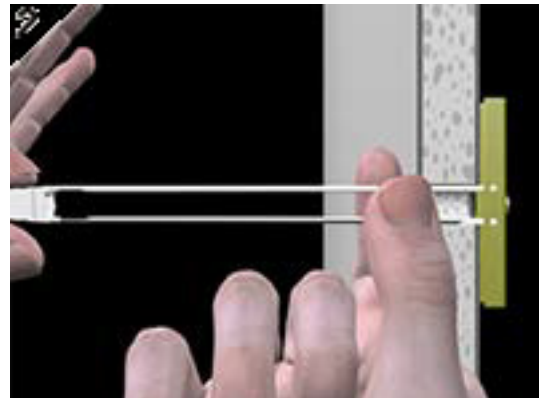

Hold the ends of straps between thumb and forefinger and pull toward you until channel rests flush behind wall. Slide plastic cap along straps with other hand until flange of cap is flush with the wall.

SECTION 5: INSTALL HANDRAILS (CONTINUED)

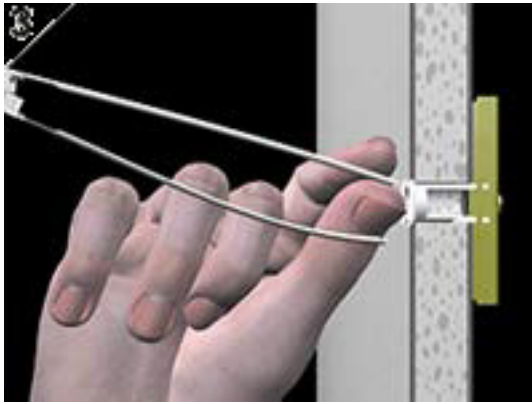

Snap straps at wall by pushing side to side snapping off straps level with flange cap.

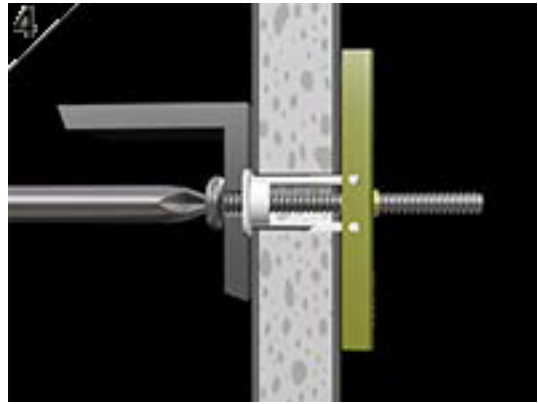

Place item over flange. Insert bolt through item and tighten until flush against item.

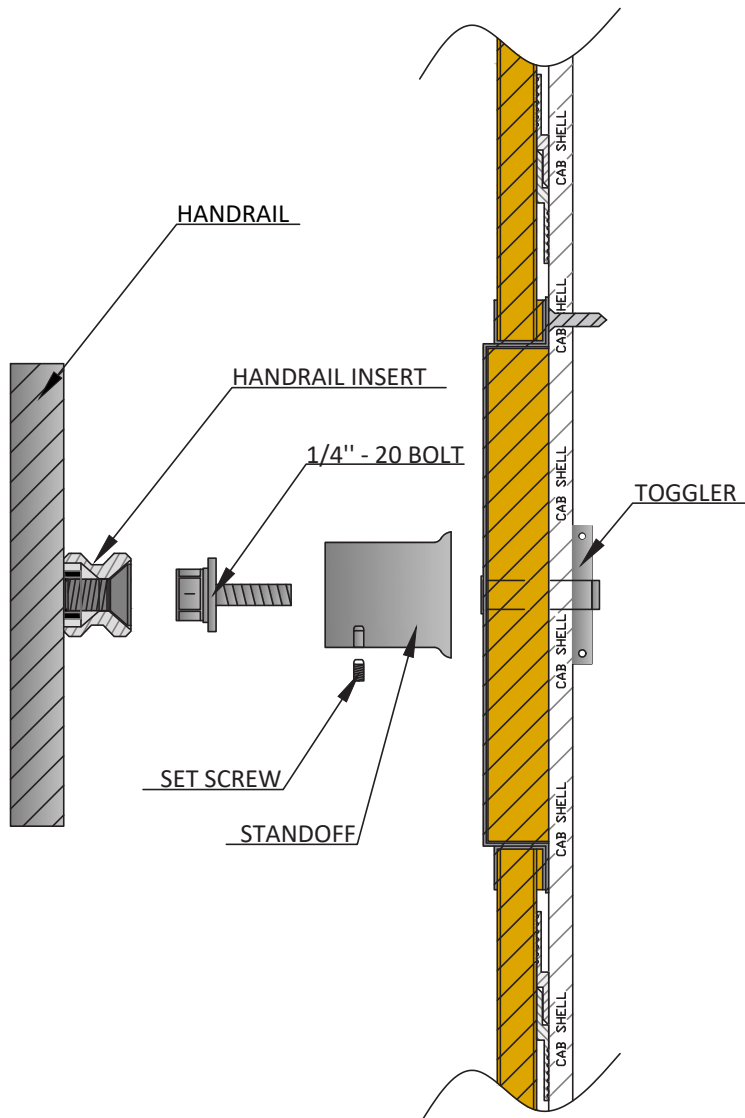

Dia. 9

Attaching standoffs to handrail.

SECTION 6: FINISHING B-LOOK PANEL SYSTEM

- 6.1. The z-clips will be installed from section 4. Locate the panels above the HMP and install them onto the clips. Ensure the panels above the HMP align with the panels below.

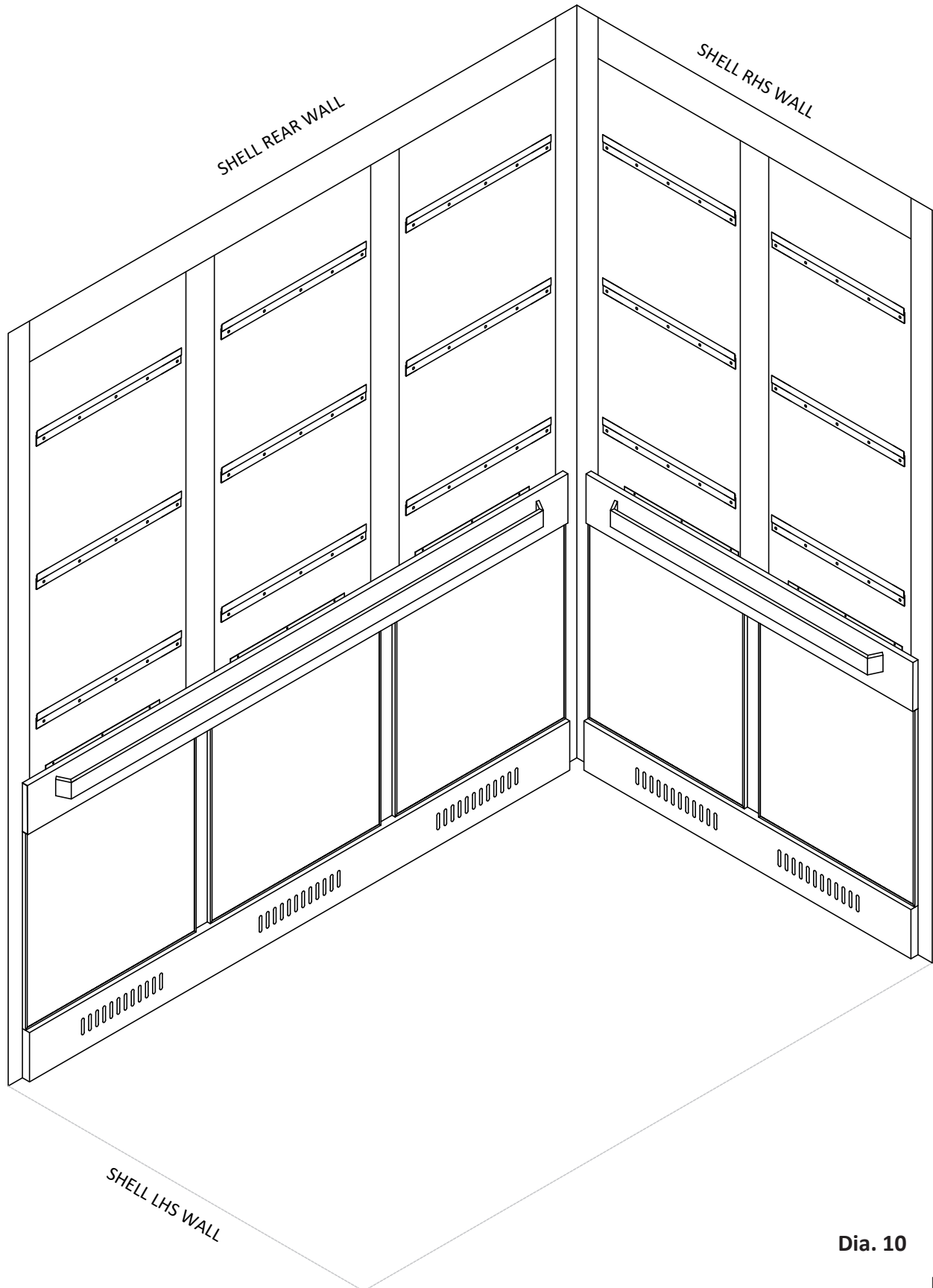

Dia. 10

SECTION 6: FINISHING A-LOOK PANEL SYSTEM (CONTINUED)

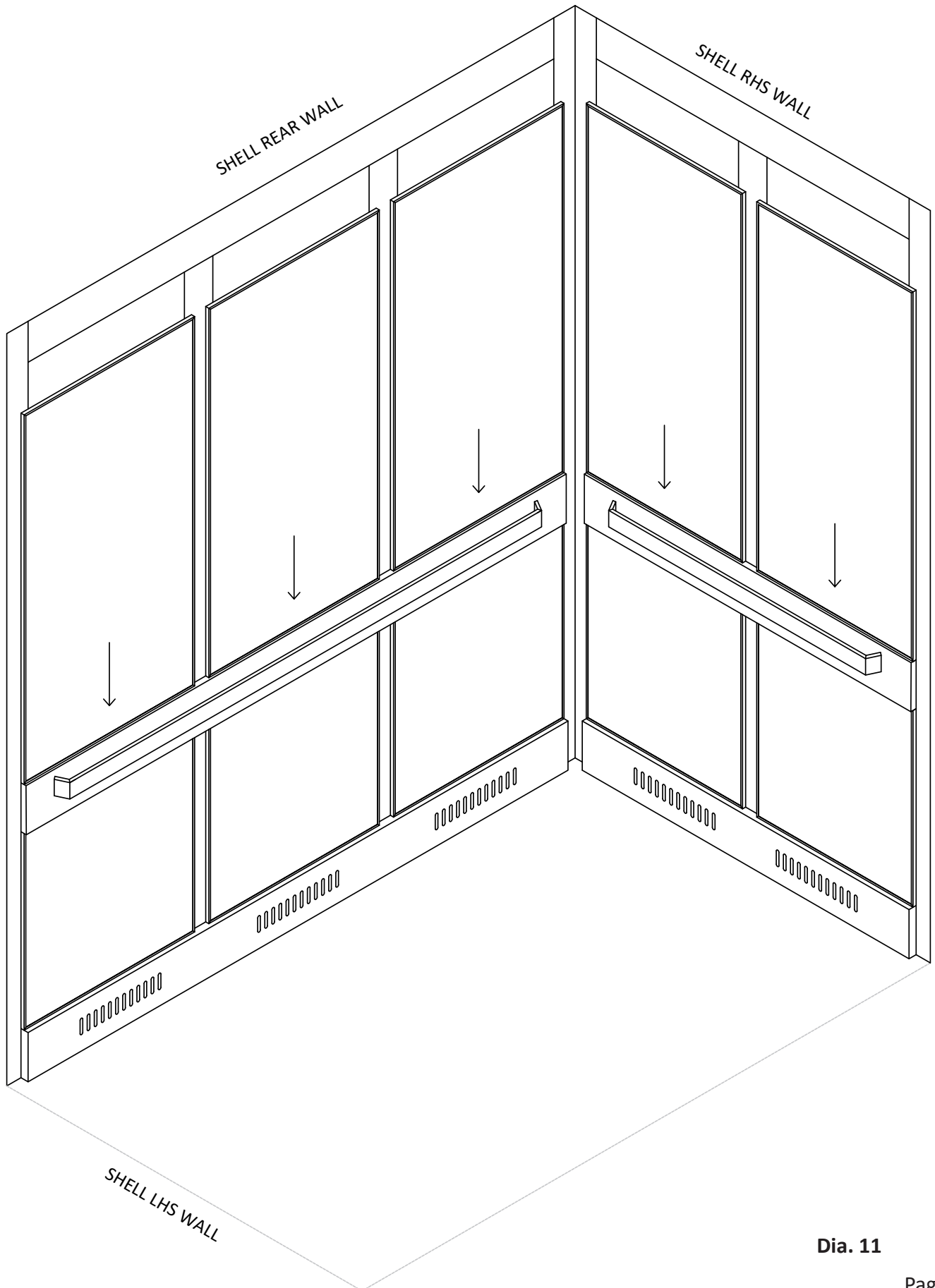

Dia. 11

SECTION 7: INSTALL TOP CAP PANELS

- 7.1. The Top Cap is installed similarly to the HMP. Set the tabs behind the B-Look panels and secure the Top Cap in place by fastening the upper tabs through the shell.

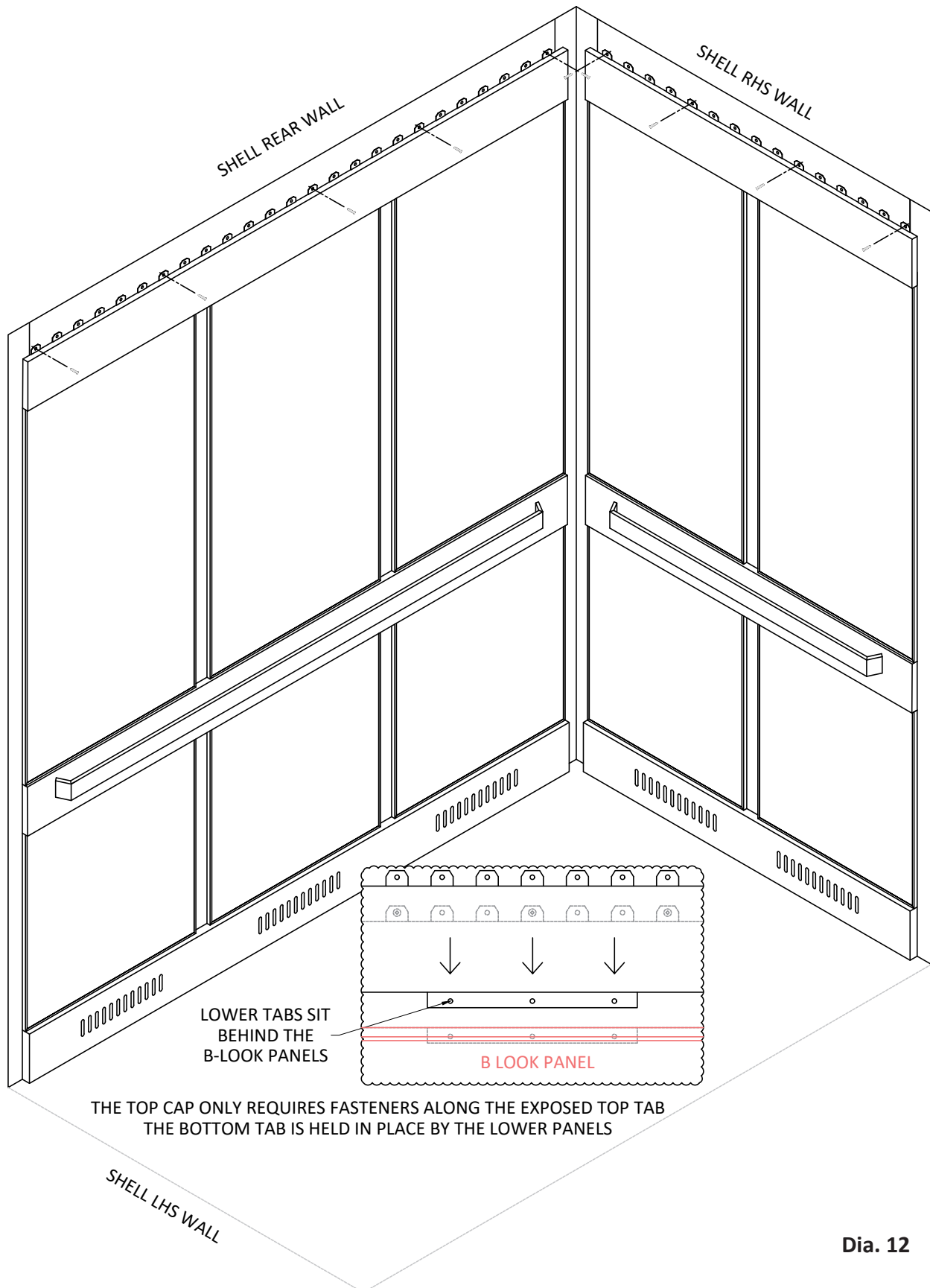

SECTION 7: INSTALL TOP CAP PANELS (CONTINUED)

- 7.2. If removable pad hooks were purchased, you can now install them by inserting the hook into one of the slots located along the top of the top cap. If button pad hooks were selected, you can install them now (Dia. 13).



Note: Refer to the drawings for the pad hook install height. Protective pads are ordered to fit the installed height of the cab pins.

- 7.3. Remove the plastic covering from all metal panels once install is complete.

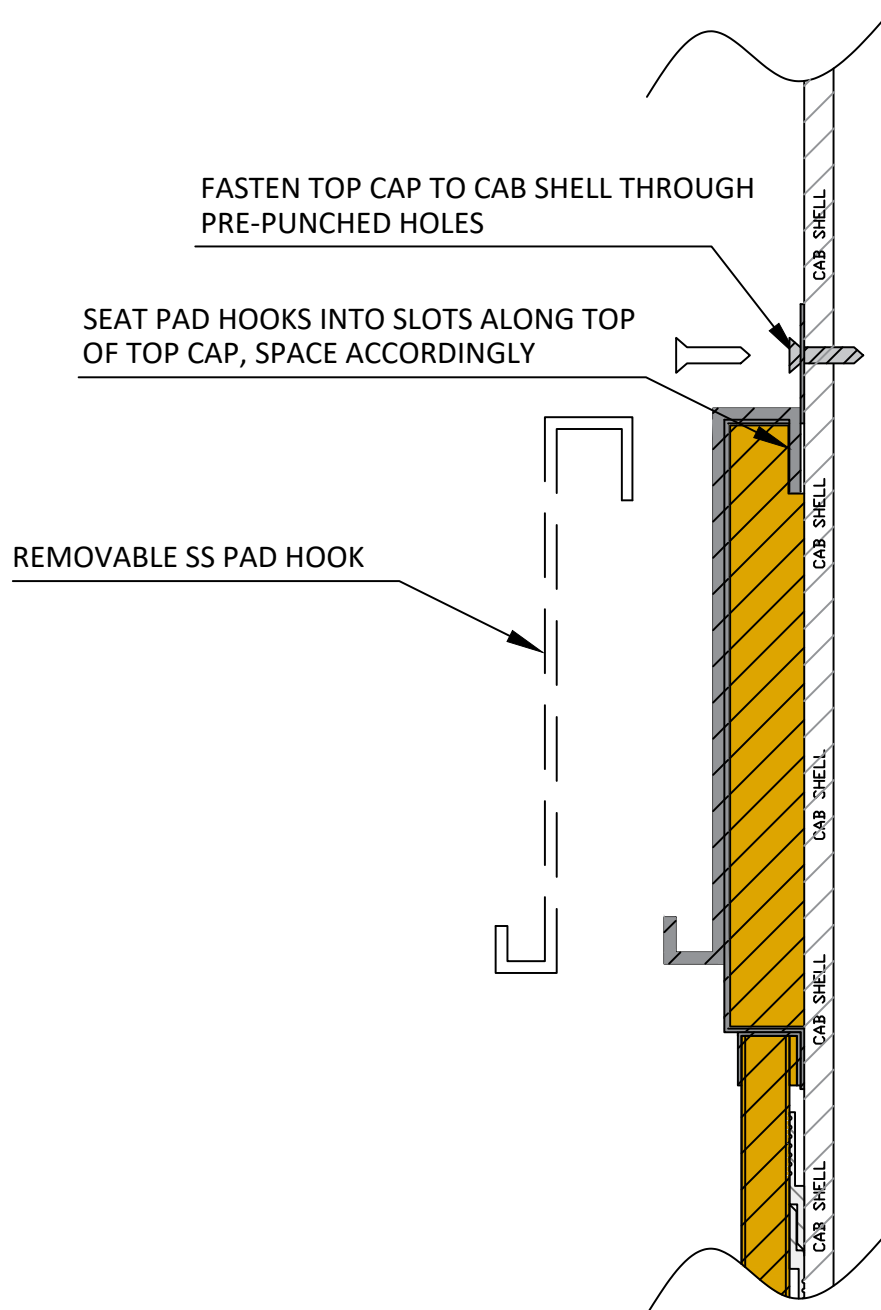

Dia. 13
Top cap detail.

SECTION 8: INSTALL ALTERNATE TOP CAP

- 8.1. If your cab does not have a drop ceiling, your Top Cap will arrive with a separate substrate. Fit and screw the substrate into the wall ensuring a small gap is left between to top of the B-Look panels for the thickness of the stainless steel (Dia. 14).
- 8.2. Install the skin onto the substrate using two way tape (Dia. 15 to 17).
- 8.3. Remove the plastic covering from all metal panels once install is complete.

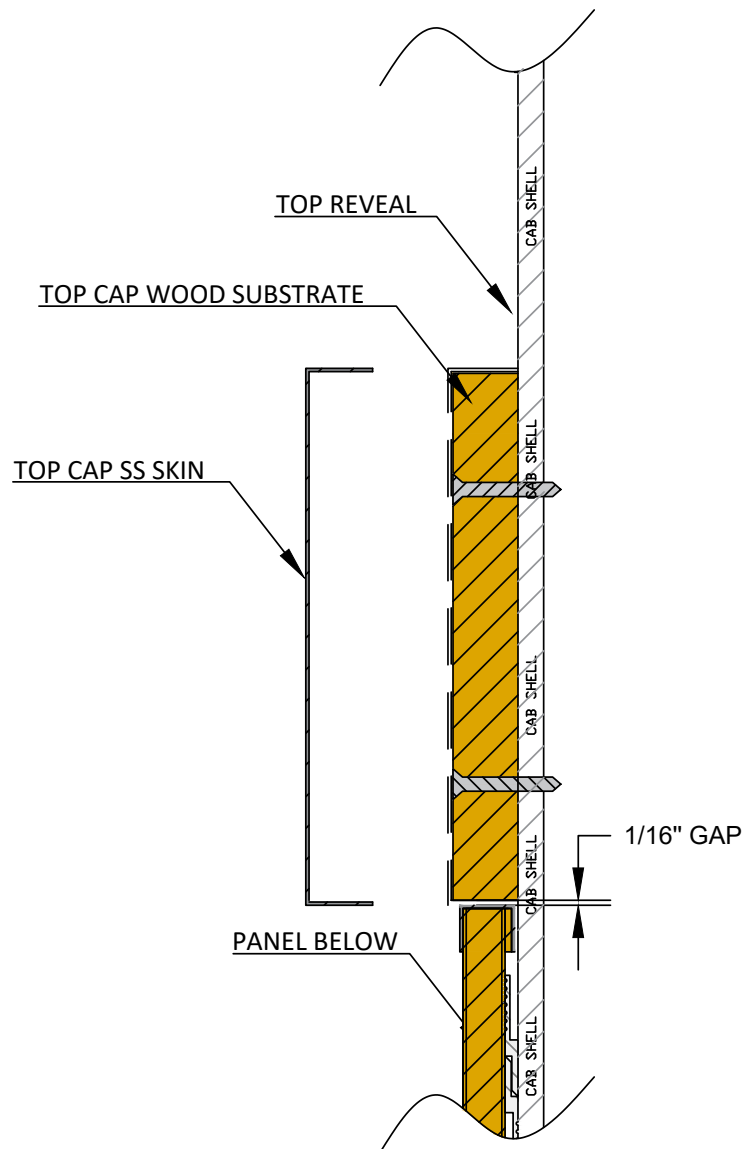

Dia. 14

Top cap detail (no drop ceiling).

SECTION 8: INSTALL ALTERNATE TOP CAP (CONTINUED)

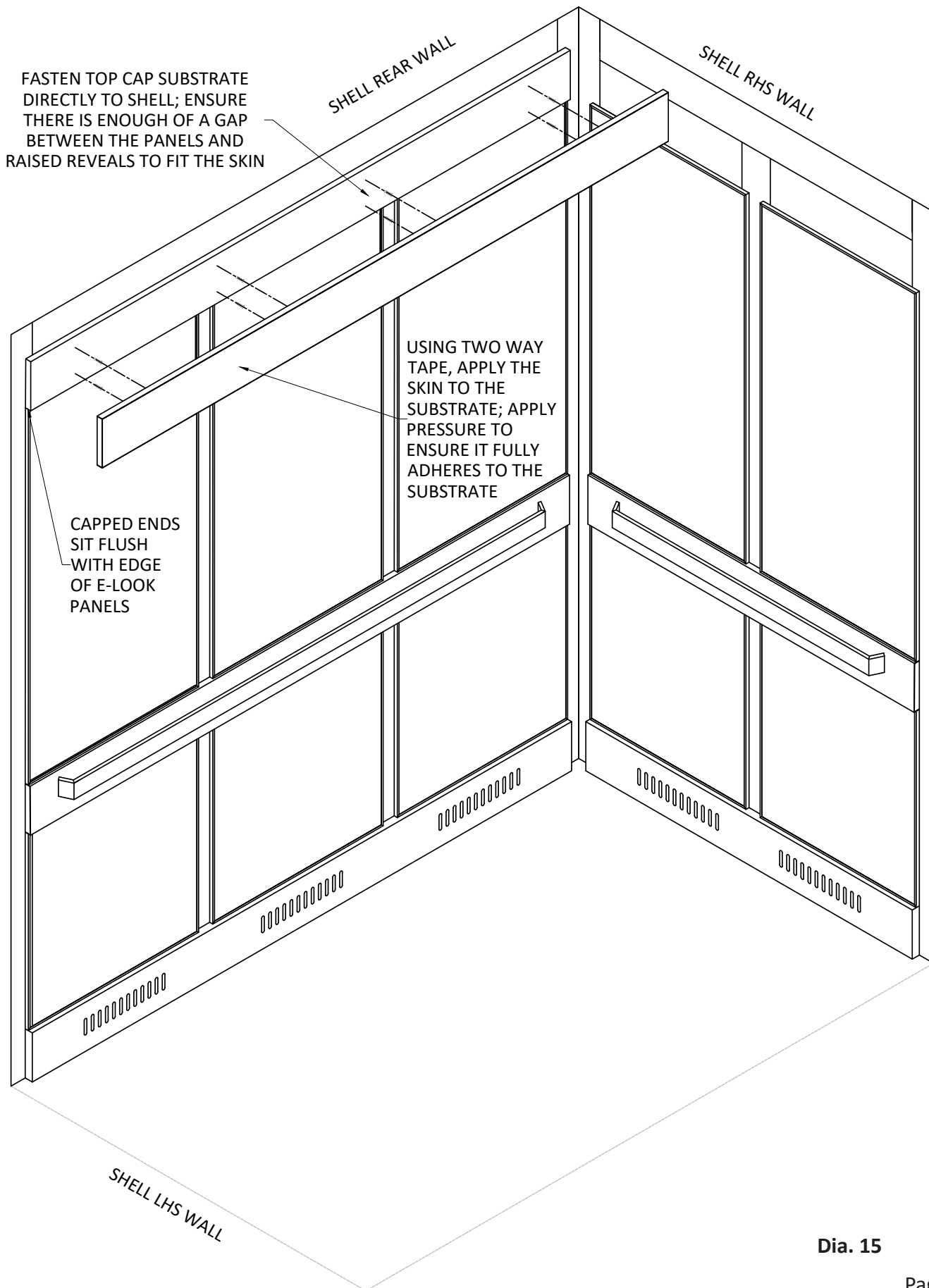

SECTION 8: INSTALL ALTERNATE TOP CAP (CONTINUED)

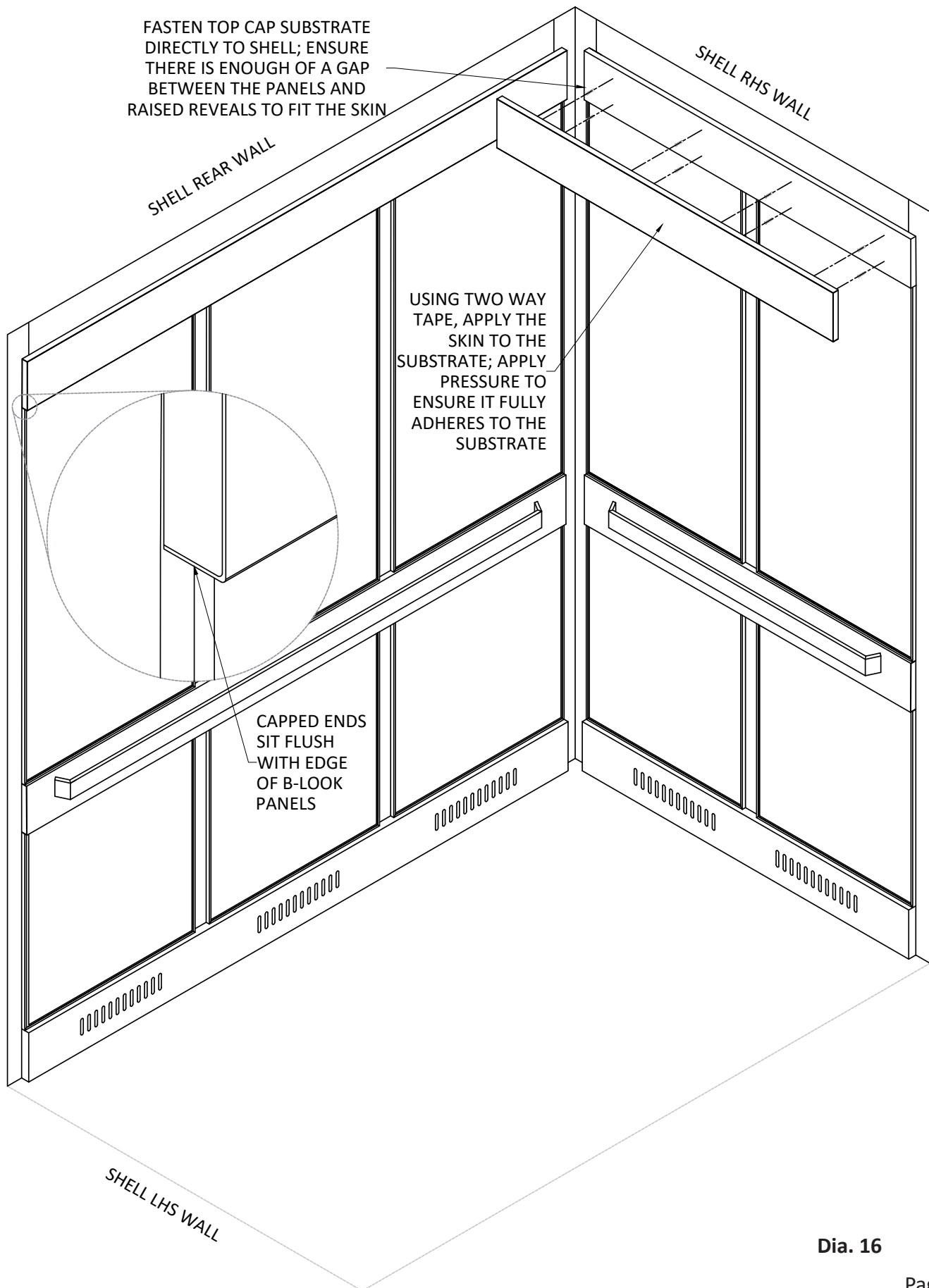

SECTION 9: B-LOOK INSTALL COMPLETE

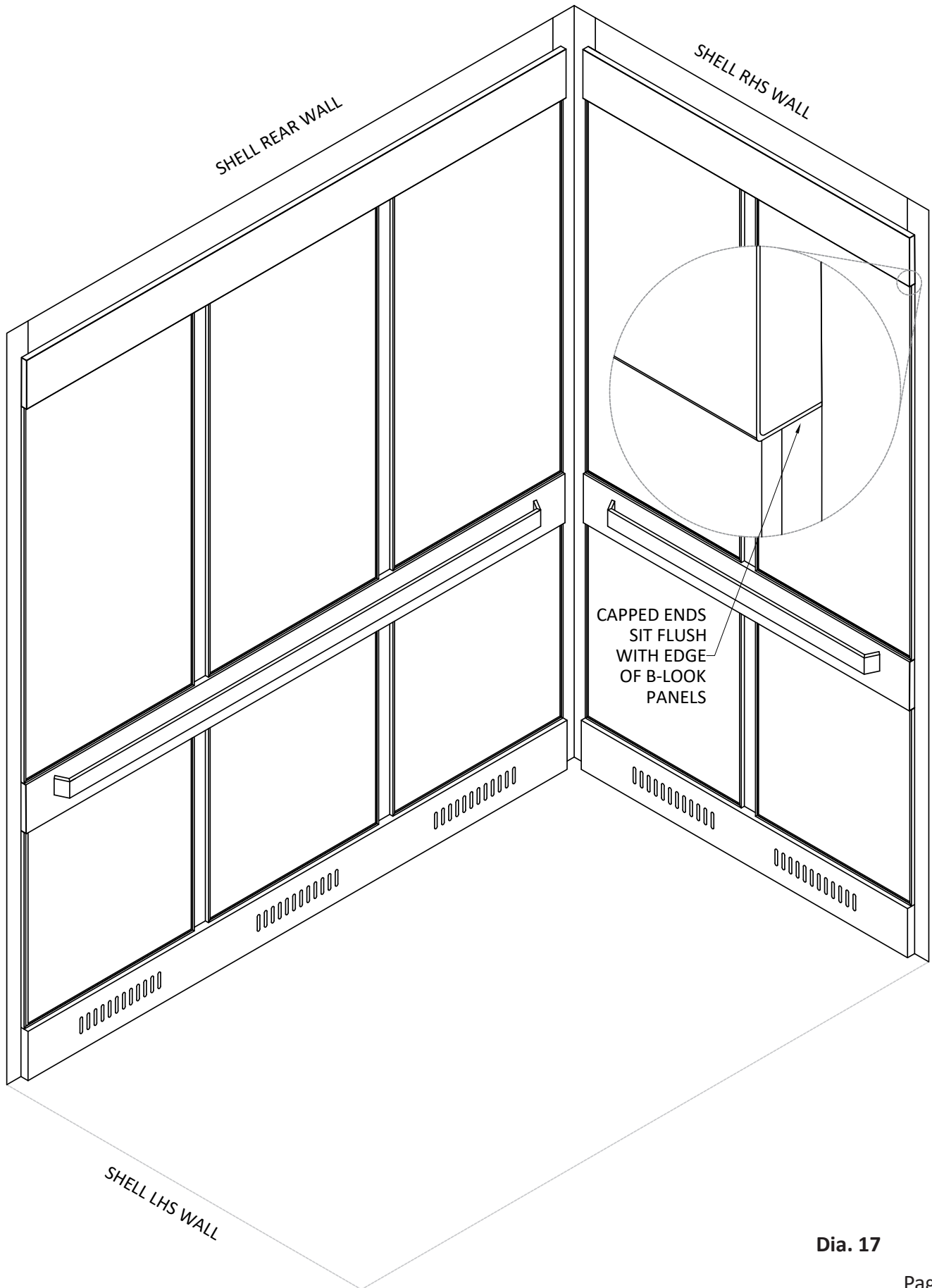

Dia. 17

GLOSSARY

Canopy:

The roof of the cab.

The top structural component of the shell.

The canopy houses the emergency hatch.

The canopy may have various electrical and mechanical components attached to its surfaces, both interior and exterior.

Non-Access Walls:

Any elevator cab wall which does not have an entrance.

Return Panel:

The wall of the cab adjacent to the entrance.

The return panel may contain the control panel, phone box and/or service panel.

The car door will slide behind the return panel.

Reveals:

Area of the elevator cab walls not covered by the panels.

This area is usually covered with stainless steel or plastic laminate.

Strike Post or Slam Post:

Part of the door frame on which the door closes.

For technical support on the B-Look Panel installation, please contact us at:

Elevator Cab Renovations

Office: (613) 745-4870

Toll Free: 1-877-745-4870

ecr@elevatorcabs.ca

Office Hours : 6:30 AM to 3:30 PM Eastern Standard Time



UNIVERSAL BAFFLE STRIP

TO BE UTILIZED WHEN ADDING
VENTILATION SLOTS TO AN
EXISTING CAB

INSTALLATION INSTRUCTION

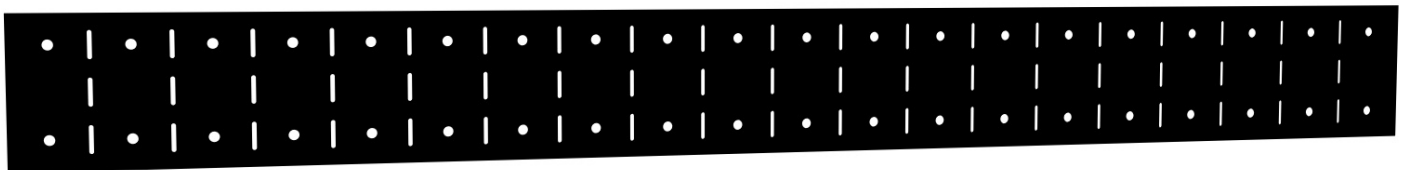

TOOLS REQUIRED

- Drill
- Jigsaw or Grinder
- Rivet Gun
- Rivets (max dia 3.2mm)
- or
- Screws (max dia 3.2mm)

CAB COMPONENTS TO BE INSTALLED

Universal Baffle Strip(s) to be cut to size to suit shell opening(s)

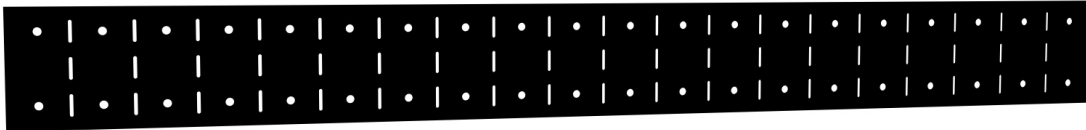

OVERVIEW

- 0.1. Included with your package is a universal baffle strip. The universal baffle strip is designed to be installed into open vent slots in the cab shell in order to prevent material passing through the vent slots into the hoist way (as per ASME-A-17.1/B-44). The universal baffle strip is intended to be installed from the cab shell interior, prior to the installation of the cab finishes. Please refer to the following instructions to properly install your universal baffle strip.

SECTION 1: PREPARE SITE FOR INSTALLATION

- 1.1. Once removal of the existing cab finishes are complete, determine if additional venting will be required.
- 1.2. If additional venting is required (as per ASME-A-17.1/B-44) locate and cut holes into the shell so that they will be hidden by the hollow vented kick plates (or hang on panels). Usually a 2'' (H) x 10'' (L) rectangular cut out is created off the finished floor for this purpose.
- 1.3. A typical side wall will have two cut-outs; a rear wall will typical have three cut outs.
- 1.4. Additional cut outs may also be required above the wall finishes close to the canopy (refer to ASME-A-17.1/B-44).

1 SECTION 2: INSTALL UNIVERSAL BAFFLE STRIP

- 2.1. Begin by determining the span of the vent to be filled. The universal baffle strip is segmented; this allows the material to be bent inwards and outwards. Starting at one end, create a 90 degree bend in the strip followed by a 90 degree bend back (Dia .1).

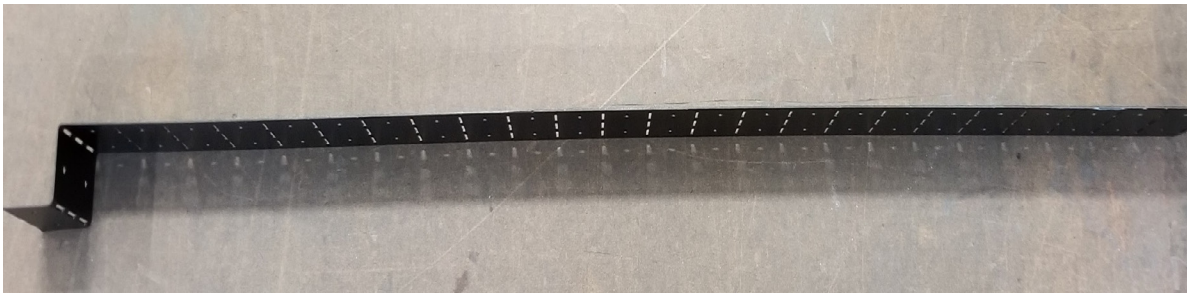

Dia. 1

Universal baffle strip, one end bent.

- 2.2. From this bend, follow the linkages until the span of the vent is reached (or as much as possible) and mirror the bends (Dia. 2). Use more or less linkages to suit the style and depth of the vent holes.

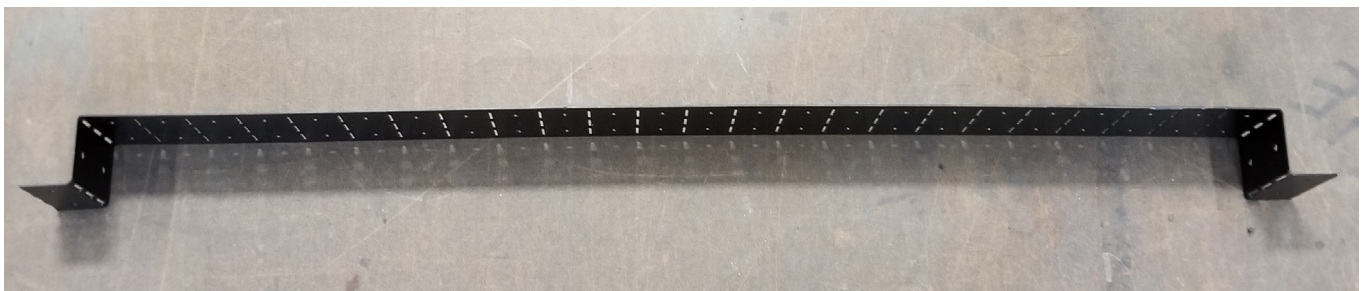

Dia. 2

Universal baffle strip, both ends bent, excess trimmed.

SECTION 2: INSTALL UNIVERSAL BAFFLE STRIP (CONTINUED)

- 2.3. Trim the excess material and retain the remainder of the baffle strip for additional vents if applicable.
- 2.4. Fit the baffle strip into the vent slot (Dia .3) and secure to the cab shell with screws or rivets (Dia .4).



Dia. 3
Universal baffle strip, ready for installation.

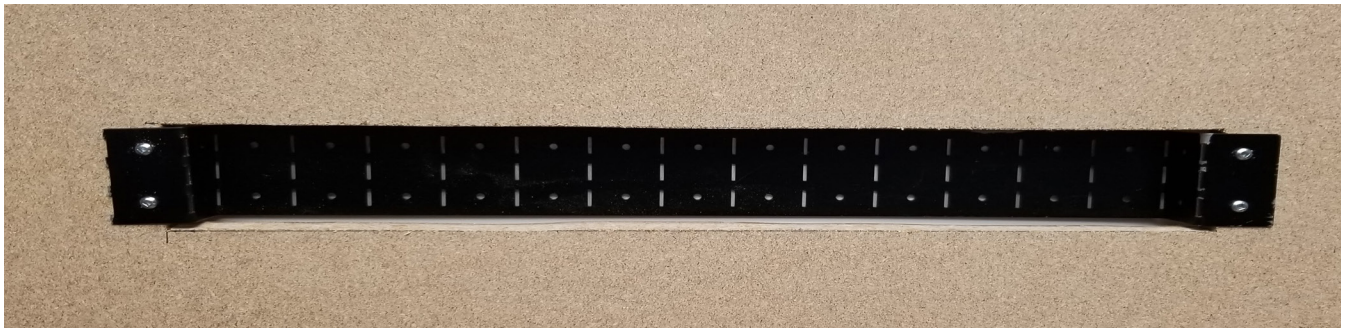

Dia. 4
Universal baffle strip installed, secured with fasteners.

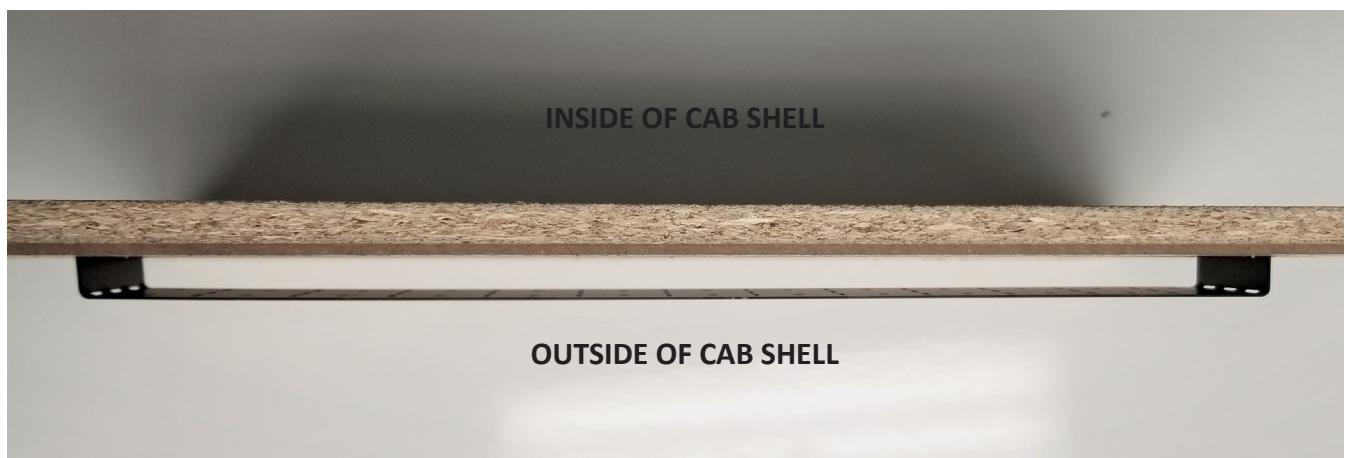

Dia. 5
Section view of universal baffle strip.

- 2.5. Once the vent slots and baffle strip are in place, proceed with installing the new cab finishes.