

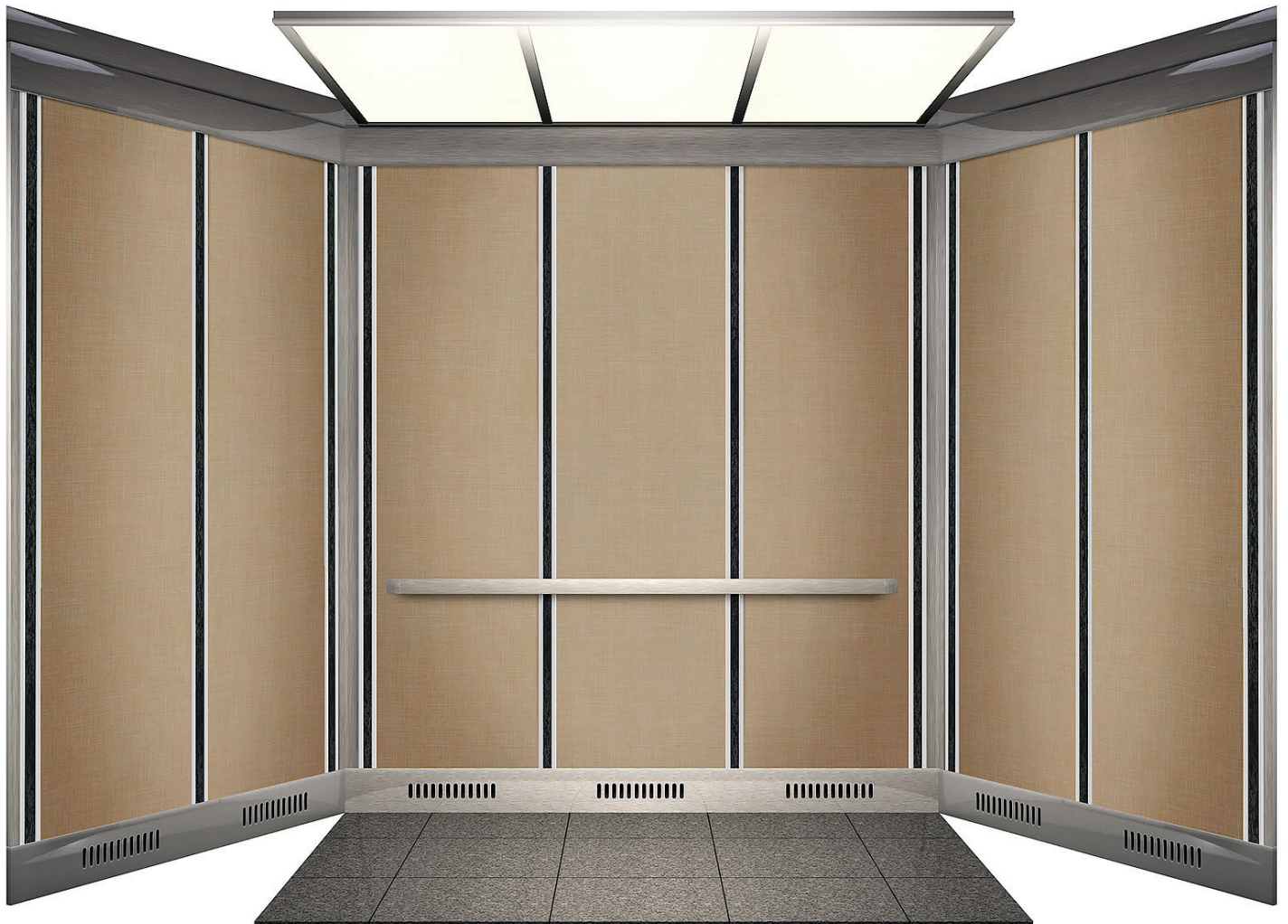

# **C-look**™ **Express**

PANEL FITMENT SYSTEM

## INSTALLATION INSTRUCTIONS



# CAB COMPONENTS TO BE INSTALLED

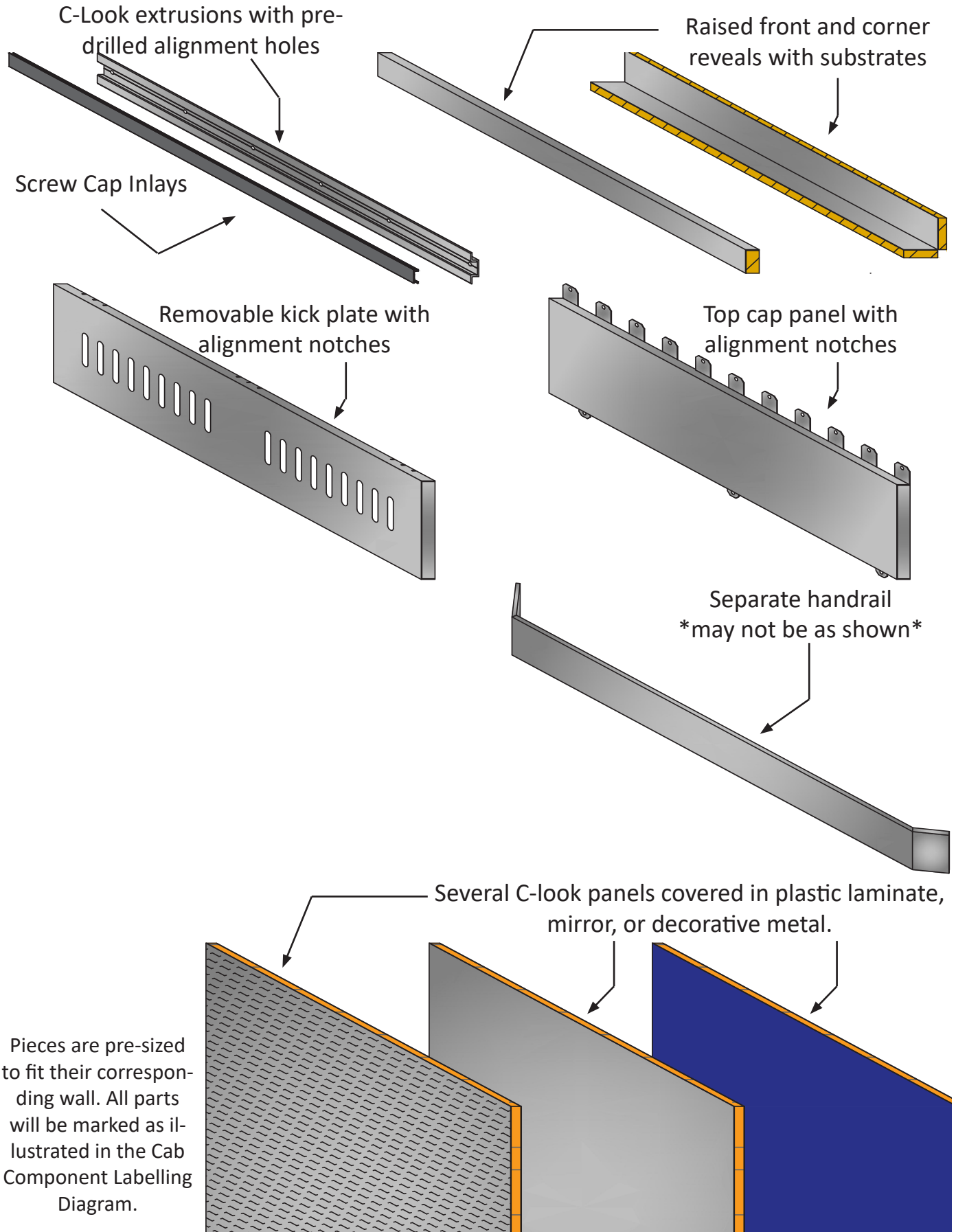

## TOOLS REQUIRED

- Measuring Tape
- Drill
- Frame Square
- Ladder
- 2" or 3" Paint Brush for Latex Paint

## CAB COMPONENT LABELLING

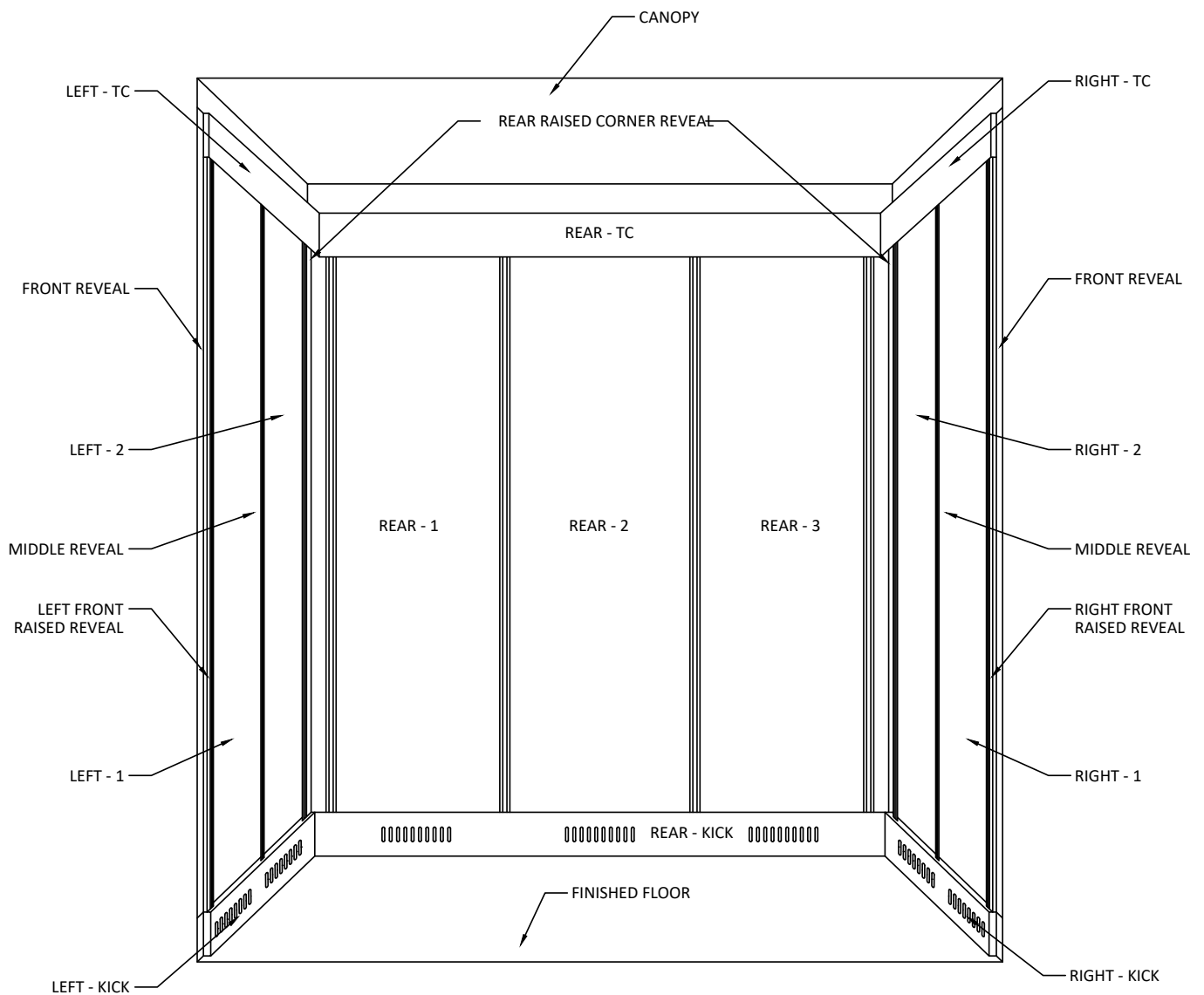

Dia .1

## SECTION 1: UNPACKING

- 1.1. When your new C-Look™ cab arrives, transport it near to the cab you will be renovating and organize the crates so that they will be easily accessible.

The crate's contents are itemized on its surface.

One box will be labelled "Open First". It contains the drawings, instructions, hardware & adhesive.

- 1.2. Carefully un-crate the cab package, making sure that none of the components are damaged.
- 1.3. Check the colours, features, and dimensions of the components against your order before you begin removing the existing elevator interior.
- 1.4. Note the labeling on the components on the previous page. The labels indicate the order in which the components will be installed and will help you identify the correct component called for in the instructions.

If you have any questions at this point, contact ECR before going ahead with any part of the installation.

For technical support on the C-Look Panel installation, please contact us at:

**Elevator Cab Renovations**  
Office: (613) 745-4870  
Toll Free: 1-877-745-4870  
ecr@elevatorcabs.ca

Office Hours : 6:30 AM to 3:30 PM Eastern Standard Time

## SECTION 2: PREPARE SITE FOR INSTALLATION

- 2.1. Remove all materials being replaced from the existing cab, stripping the cab down to the bare shell. Clean any debris and oil from the cab shell.
- 2.2. If the drop ceiling is being replaced, paint the perimeter of the canopy 4" in from all sides with matte black latex paint (paint is not included). The remainder of the canopy will not be visible once the new ceiling is installed.
- 2.3. If the floors are being replaced, remove existing floor and install new flooring before installing the C-Look panels. If the floors are not being replaced, use a protective covering to prevent damage to the floor.

## SECTION 3: INSTALL CAB REVEALS

- 3.1. Dry fit the front reveals and trim reveals as necessary. Reveals can be up to 1/4" short of the canopy without affecting the final look of the cab (Dia. 2).
- 3.2. If your shell has a protruding header, split the reveal where the step occurs and fit the remaining reveal piece against the step as indicated by the red dashed line (Dia. 2).
- 3.3. Apply the supplied 2-sided tape or contact cement on back side of reveals.
- 3.4. Starting at the bottom press the reveals onto the cab shell, ensuring a tight fit against the front and flush to the floor. Apply pressure to ensure the reveal adheres to the cab shell.
- 3.5. A drop ceiling will block the canopy from view; if your cab has a drop ceiling, or a drop ceiling was purchased, paint the shell walls below the canopy and between the reveals with matte black latex paint (not included). The top cap normally sits 4 inches below the canopy; paint at least 5 inches below the canopy (Dia. 2).
- 3.6. If the top cap will be visible, stainless steel horizontal reveals will be included. Fit the reveals tight against the canopy between the corners and front reveals, trimming if necessary. Apply the reveals to the shell with 2-sided tape or contact cement.



**Note: It is important to remove the protective plastic from the reveals before continuing the installation. Once the kick plates are installed the protective plastic is difficult to remove.**

# SECTION 3: INSTALL CAB REVEALS

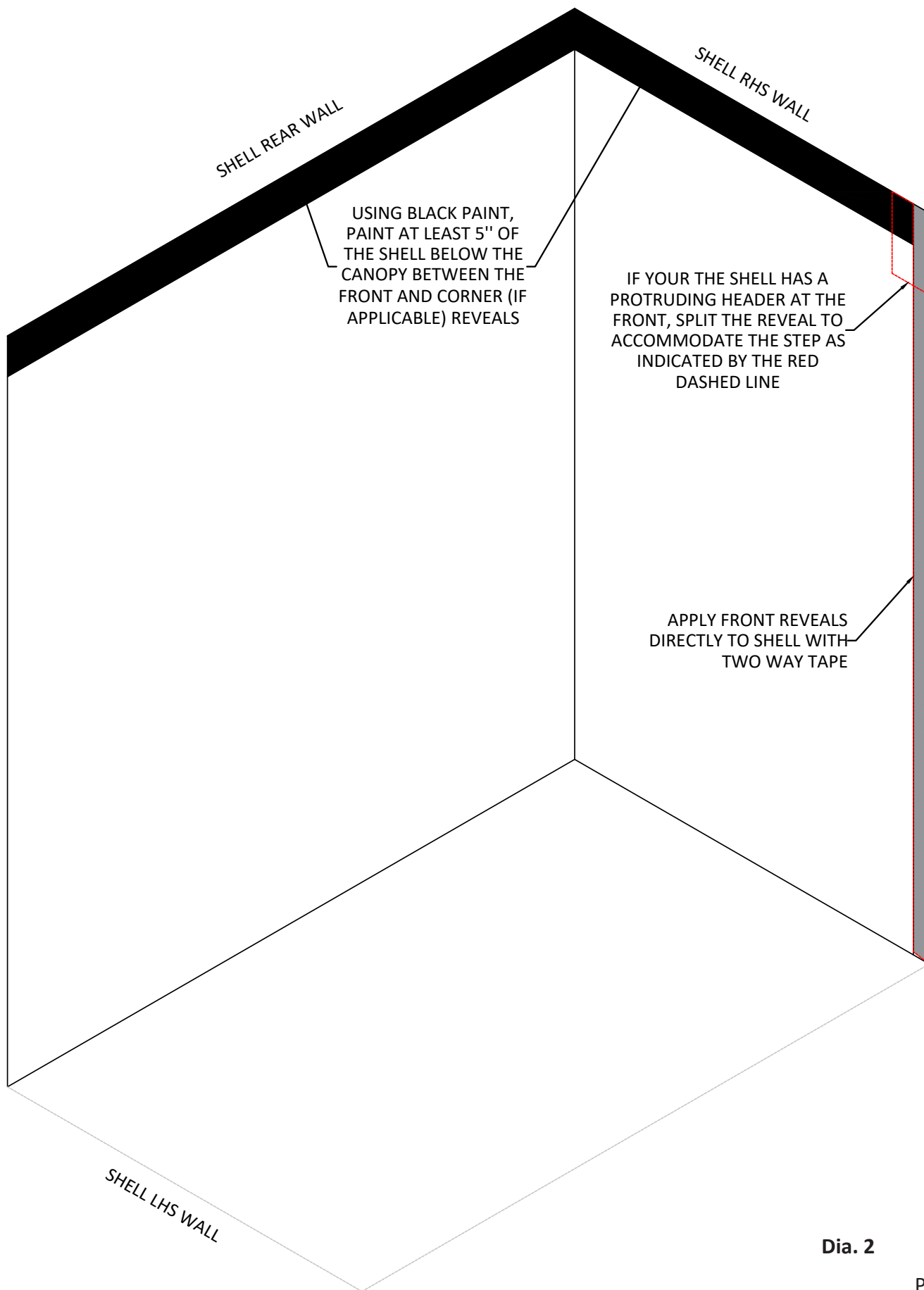

## SECTION 4: INSTALL C-LOOK PANEL SYSTEM

- 4.1. Measure the width of each wall and determine the center point. Mark a line vertically at this point (Dia. 3).
- 4.2. Removable vented kick plates are provided with a centering notch; locate this notch and align it with the center of the shell.

 **Note: The bottom of the kick plate should sit on or slightly above the finished floor. If no floor currently exists, simulate the finished floor height with an appropriate build out or shims before installing kick plates.**

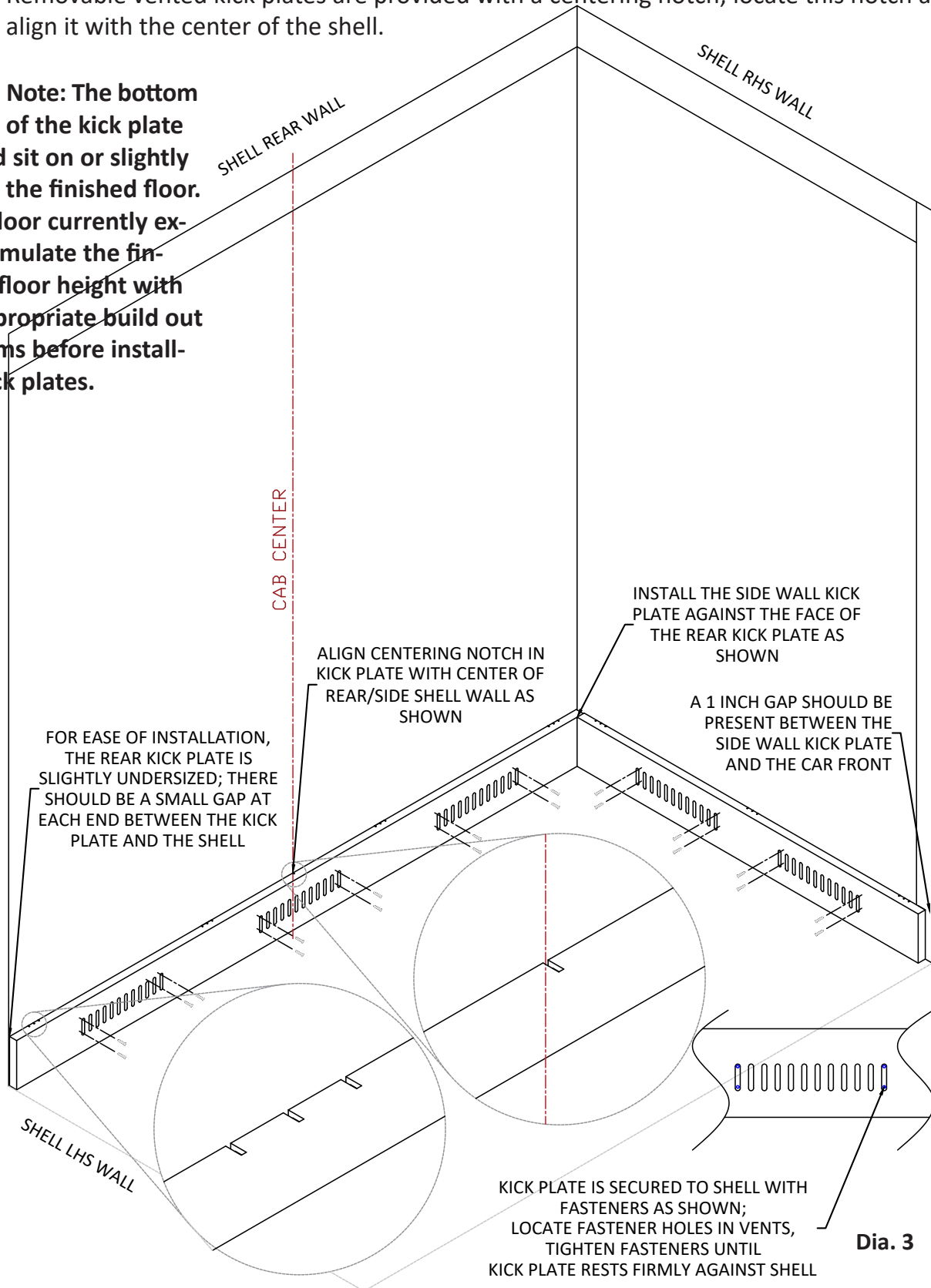

## SECTION 4: INSTALL C-LOOK PANEL SYSTEM (CONTINUED)

- 4.3. Center the kick plate on the back wall and fasten the kick plate to the wall using the mounting holes located inside the vent slots with tap screws provided (Dia. 3).



**Note:** At this point it is crucial to check that kick plates are square to adjacent walls and ensure that all kick plates are the same height on all three non-access walls before installing the panels.



**Note:** It is important to remove the protective plastic from the back, top and bottom of the kick plates prior to installation. Once installation is complete these areas are no longer accessible.

- 4.4. If additional vent holes are required, refer to the included **Universal Baffle Strip Installation Manual** for more information and instructions on how to create additional ventilation in the cab shell.

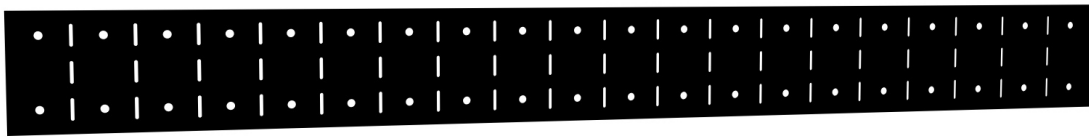

**Dia. 4**  
Universal baffle strip.

- 4.5. Locating the panel on the wall is facilitated by the use of corresponding notches on the kick plate and top cap.
- 4.6. The notches are grouped in batches of three. The middle notch aligns with the center of the C-Look extrusion. The outer notches align with outer edges of the C-Look panels and raised substrates (Dia. 5).

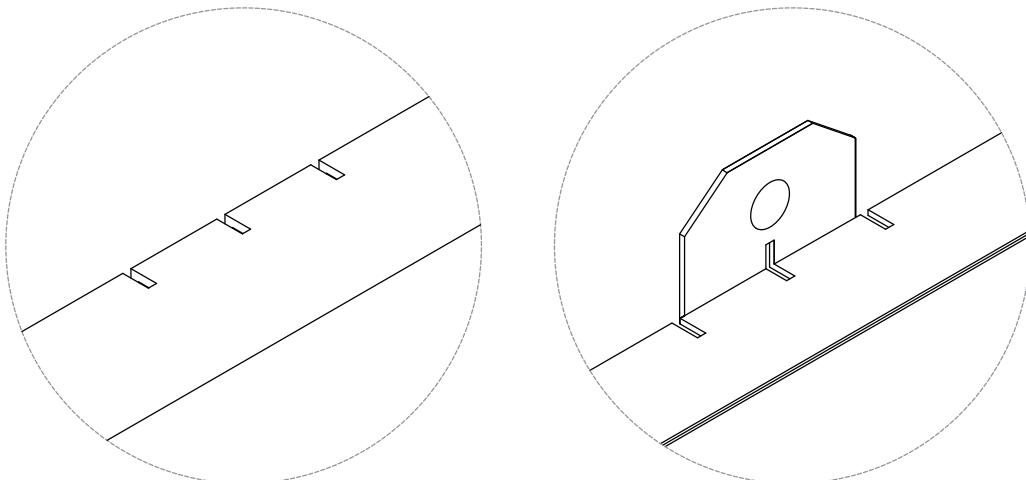

**Dia. 5**  
Alignment notches on C-Look components.



## SECTION 4: INSTALL C-LOOK PANEL SYSTEM (CONTINUED)

- 4.7. Refer to the drawings and layout the panels in the order to be installed. Set the raised corner reveals in place using the alignment notches (Dia. 6).

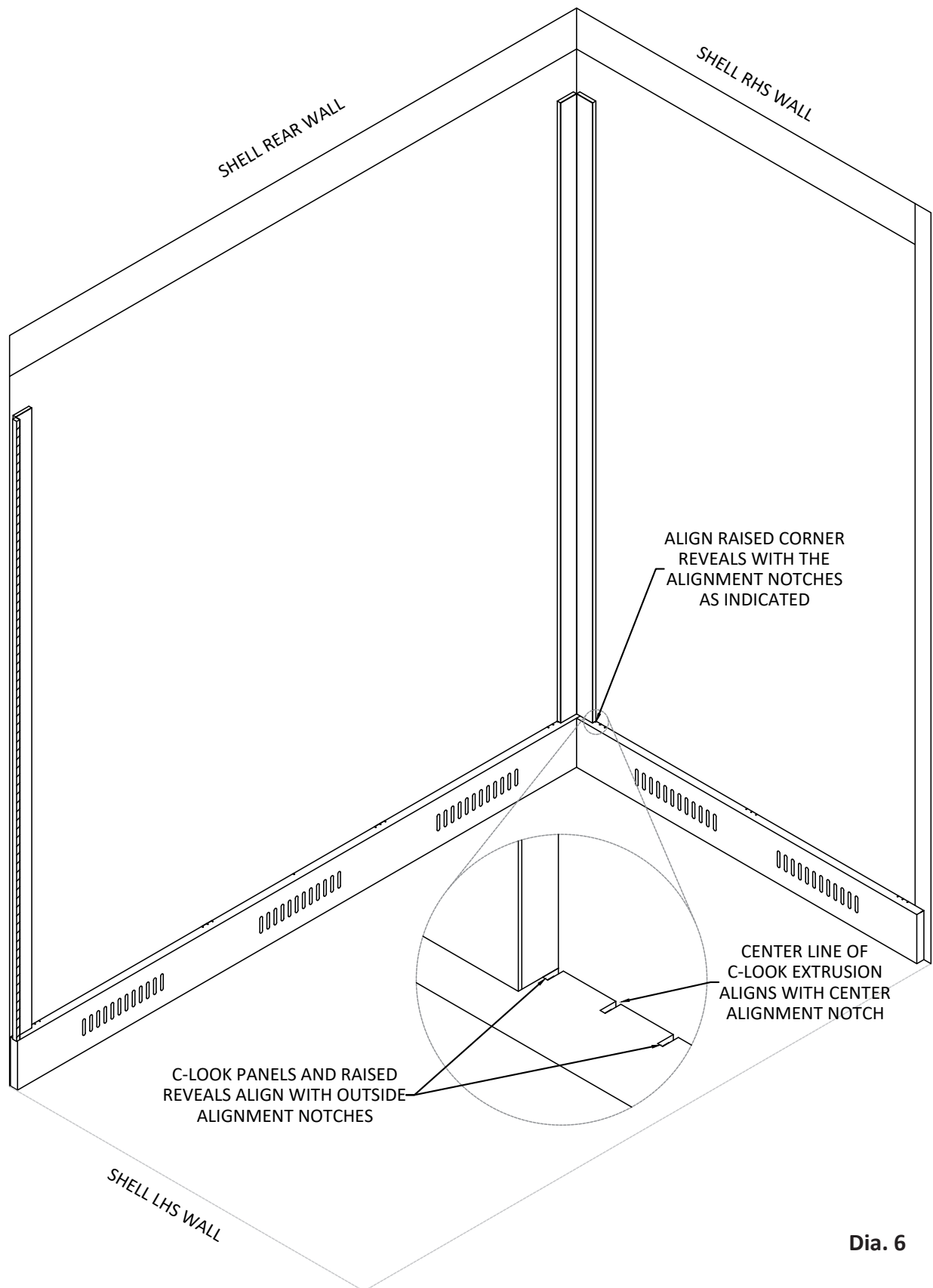

Dia. 6

## SECTION 4: INSTALL C-LOOK PANEL SYSTEM (CONTINUED)

4.8. Place a C-Look panel in place using the outside alignment notches (Dia. 7).

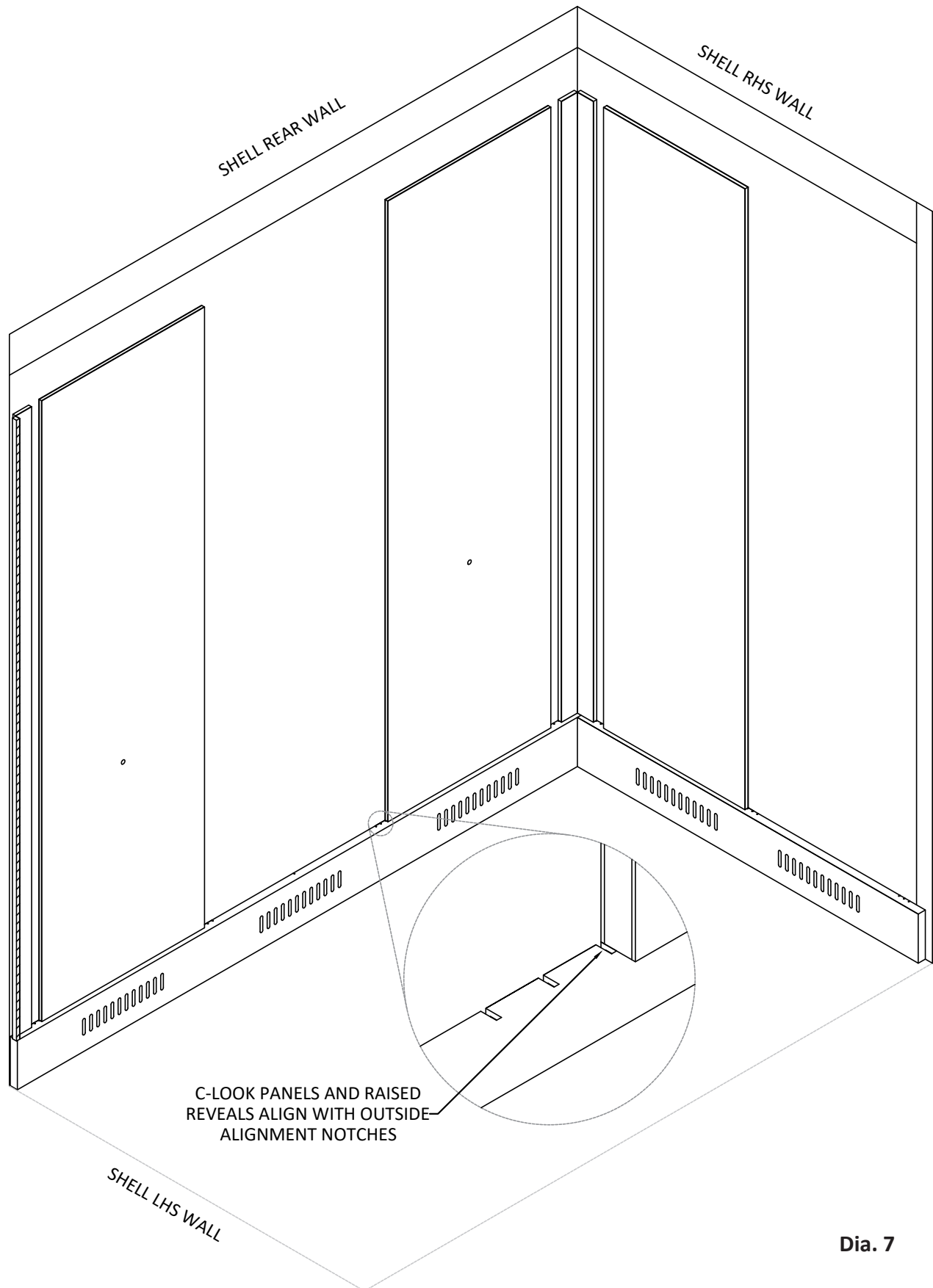

Dia. 7

## SECTION 4: INSTALL C-LOOK PANEL SYSTEM (CONTINUED)

- 4.9. Using the center alignment notch for reference, install an extrusion between the raised corner reveal and C-Look panel. Do not install any fasteners in the upper most (over-sized) hole until the Top Cap is installed (Dia. 8).



**Note: Do not over-tighten the screws. Over-tightening can collapse the C-Look Extrusion making it difficult to insert the Screw Cap Inlay.**



**Note: Do not screw in the top most (over-sized) hole in the extrusion. This hole aligns with the tabs on the Top Cap and will be secured in the next section.**

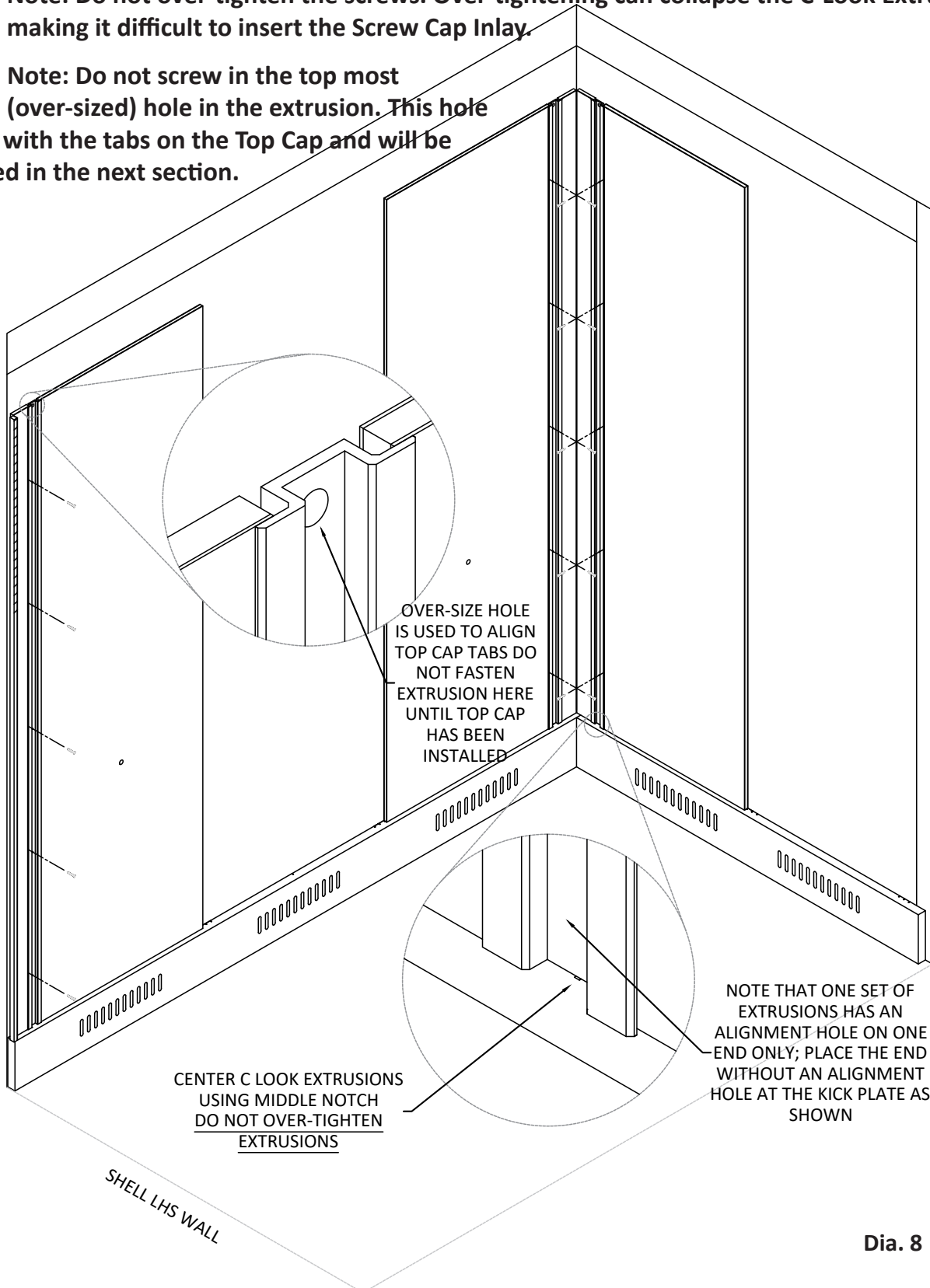

CENTER C LOOK EXTRUSIONS  
USING MIDDLE NOTCH  
DO NOT OVER-TIGHTEN  
EXTRUSIONS

NOTE THAT ONE SET OF  
EXTRUSIONS HAS AN  
ALIGNMENT HOLE ON ONE  
END ONLY; PLACE THE END  
WITHOUT AN ALIGNMENT  
HOLE AT THE KICK PLATE AS  
SHOWN

Dia. 8

## SECTION 4: INSTALL C-LOOK PANEL SYSTEM (CONTINUED)

- 4.10. Continue placing and installing C-Look panels and extrusions ensuring not to over-tighten the fasteners in the extrusions (Dia. 9 and 10).

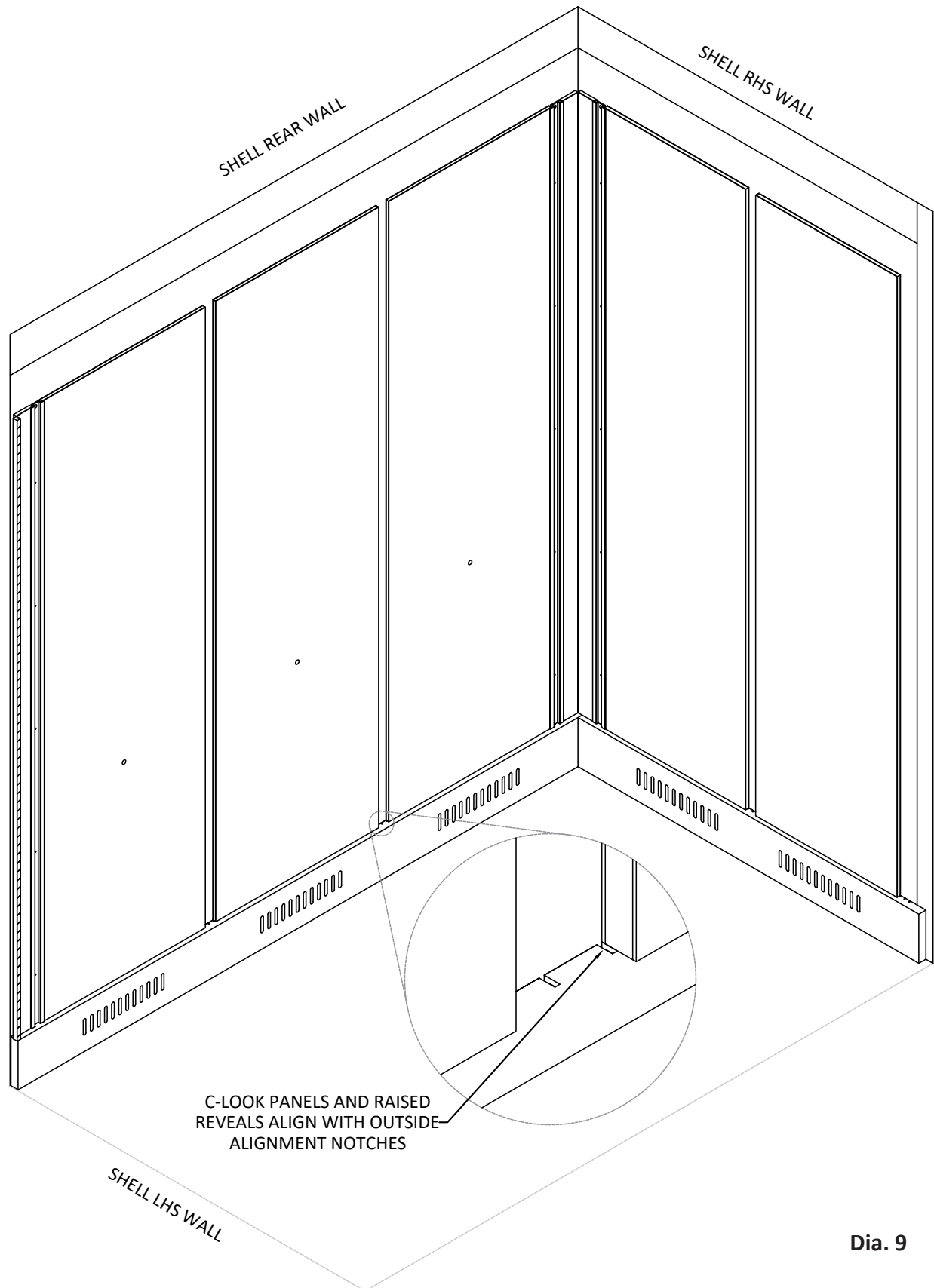

Dia. 9

## SECTION 4: INSTALL C-LOOK PANEL SYSTEM (CONTINUED)

- 4.11. Place the raised front reveal in place using the alignment notches (Dia. 10). Secure to the shell with extrusions as previously done (Dia. 11).

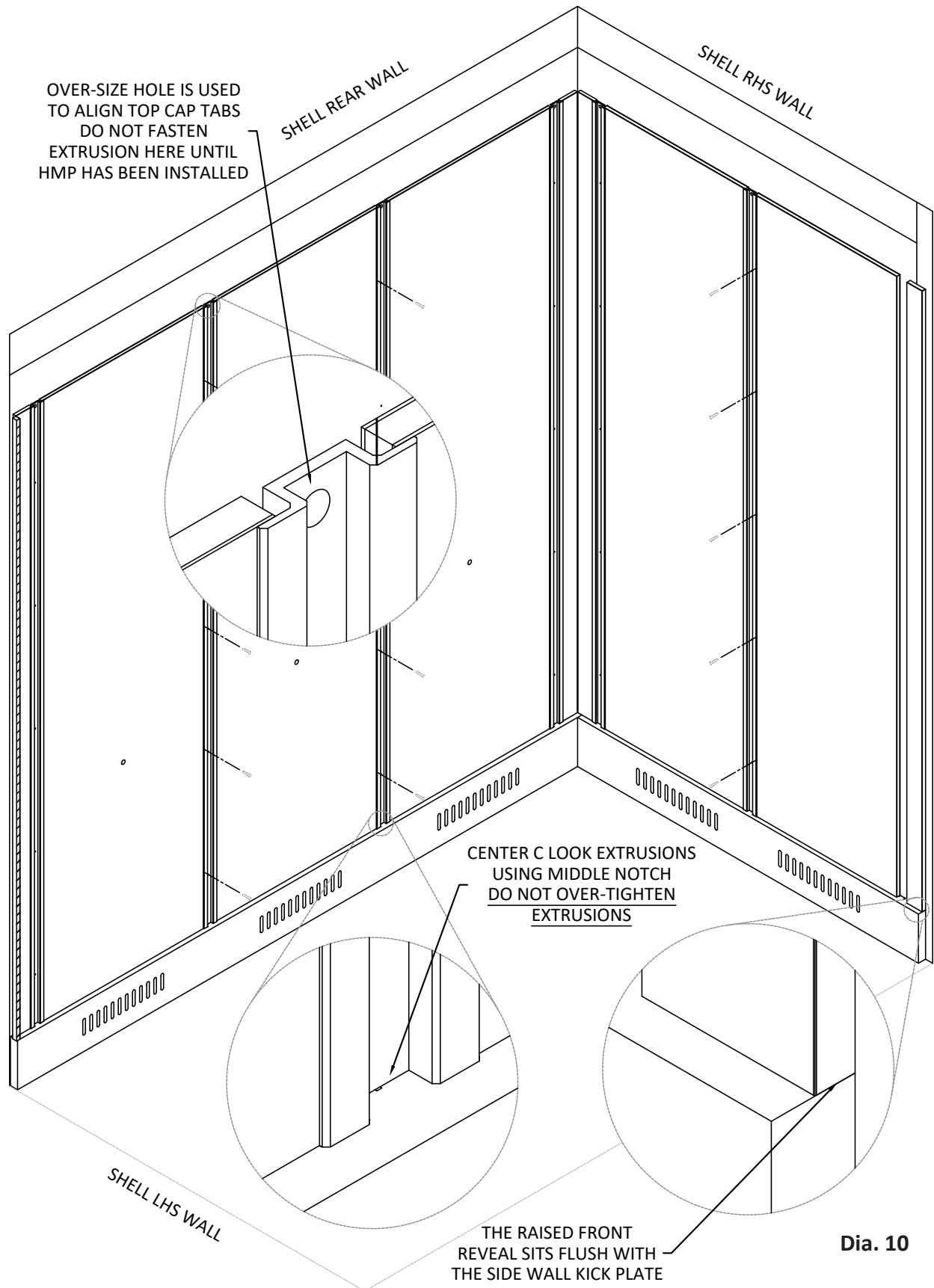

# SECTION 4: INSTALL C-LOOK PANEL SYSTEM (CONTINUED)

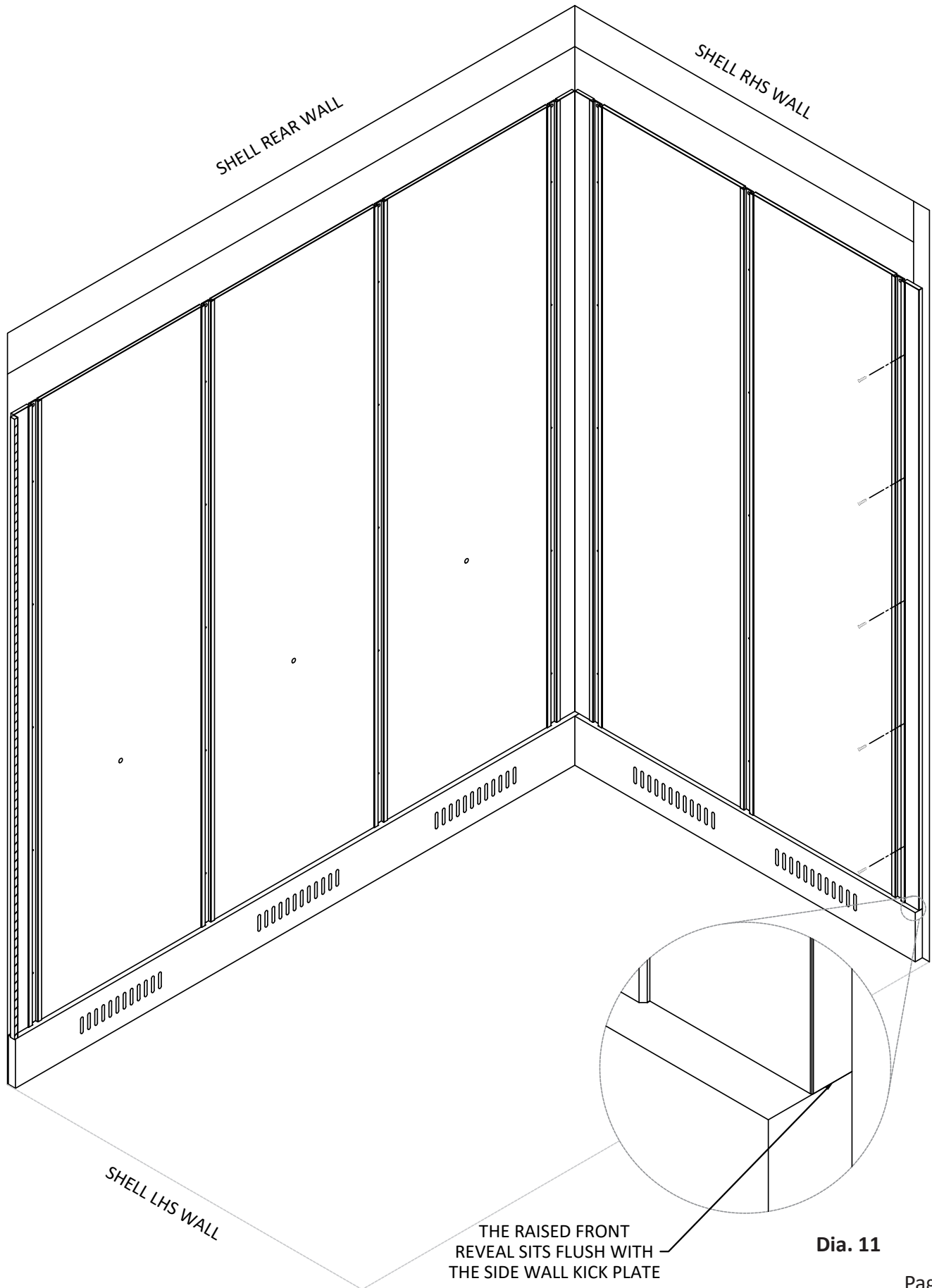

**Dia. 11**

THE RAISED FRONT REVEAL SITS FLUSH WITH THE SIDE WALL KICK PLATE

## SECTION 5: INSTALL TOP CAP

5.1. Before installing the top cap ensure the area above the wall finishes has been appropriately addressed (painted or SS reveal (if applicable), refer to section 3).

5.2. Before installing the Top Cap, remove the protective covering from the bent sides but leave the face of the panel covered (this will protect the face during installation).



**Note: It is important to remove the protective plastic from the HMP prior to installation. Once the HMPs are installed the protective plastic is difficult to remove.**

5.3. Before fastening, ensure the side Top Cap sits tightly against the rear Top Cap (trim the non-capped end if necessary). The capped end is oriented towards the front of the car. The capped end should sit flush to the outer edge of the raised front reveal (Dia. 12).

5.4. Using the alignment tabs, align the Top Cap with the extrusions and sit the tabs behind the extrusions. Drill through the holes of the extrusion into the cab shell with a 1/8" drill bit. Secure the Top Cap and extrusions to the wall using the 1" pan head screws provided.



**Note: Do not over-tighten the screws. Over-tightening can collapse the C-Look Extrusion making it difficult to insert the Screw Cap Inlay.**

5.5. To finish securing the Top Cap, drill through the holes of the exposed tabs into the cab shell with a 1/8" drill bit. Secure the tabs to the wall using the 1" pan head screws provided. It is not necessary to fasten every tab; use at least 4 fasteners to ensure the Top Cap is secured (Dia. 12).

5.6. Install pad hooks into Top Cap if required (Dia. 13).

# SECTION 5: INSTALL TOP CAP (CONTINUED)

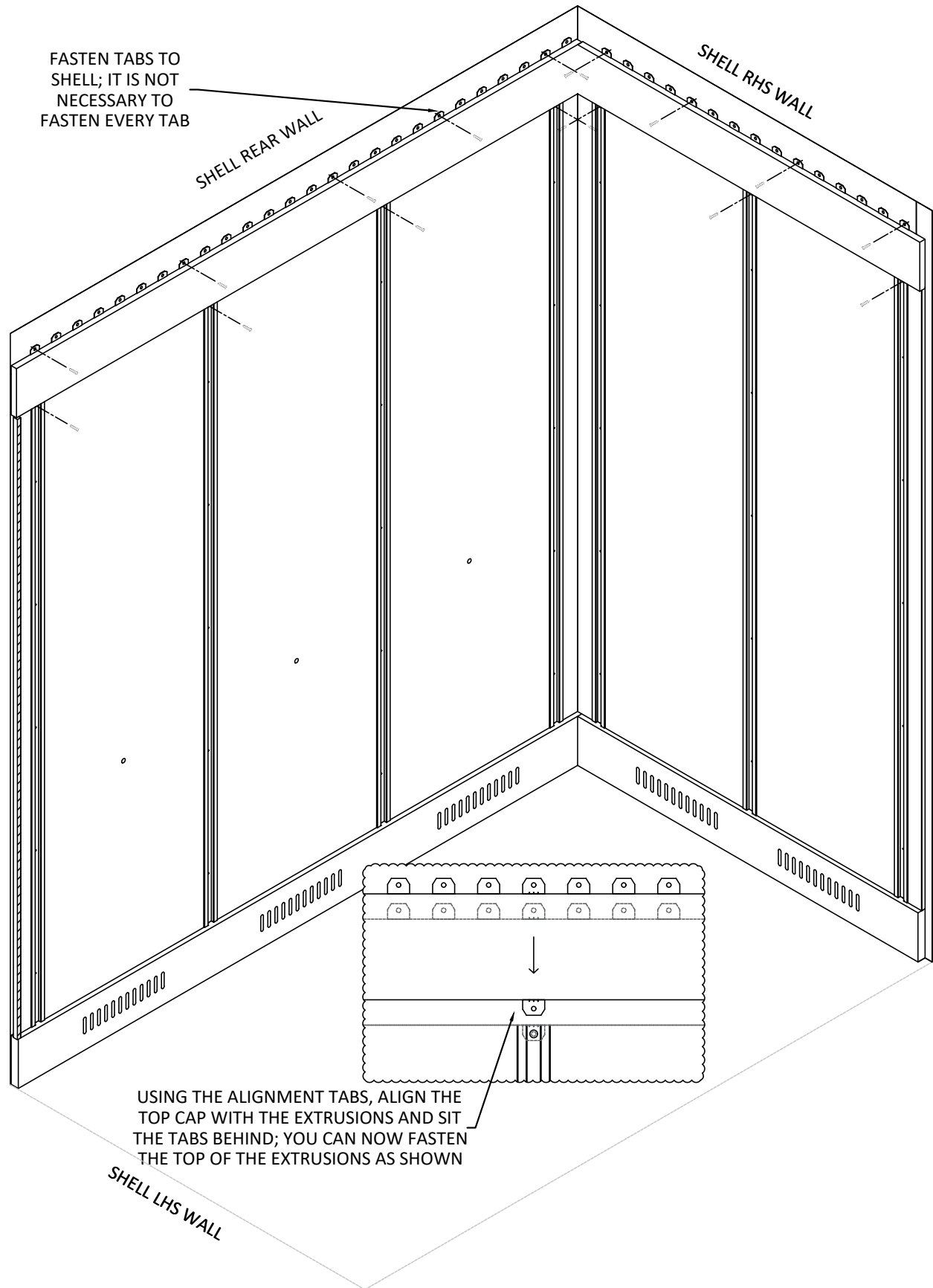



# SECTION 5: INSTALL TOP CAP (CONTINUED)

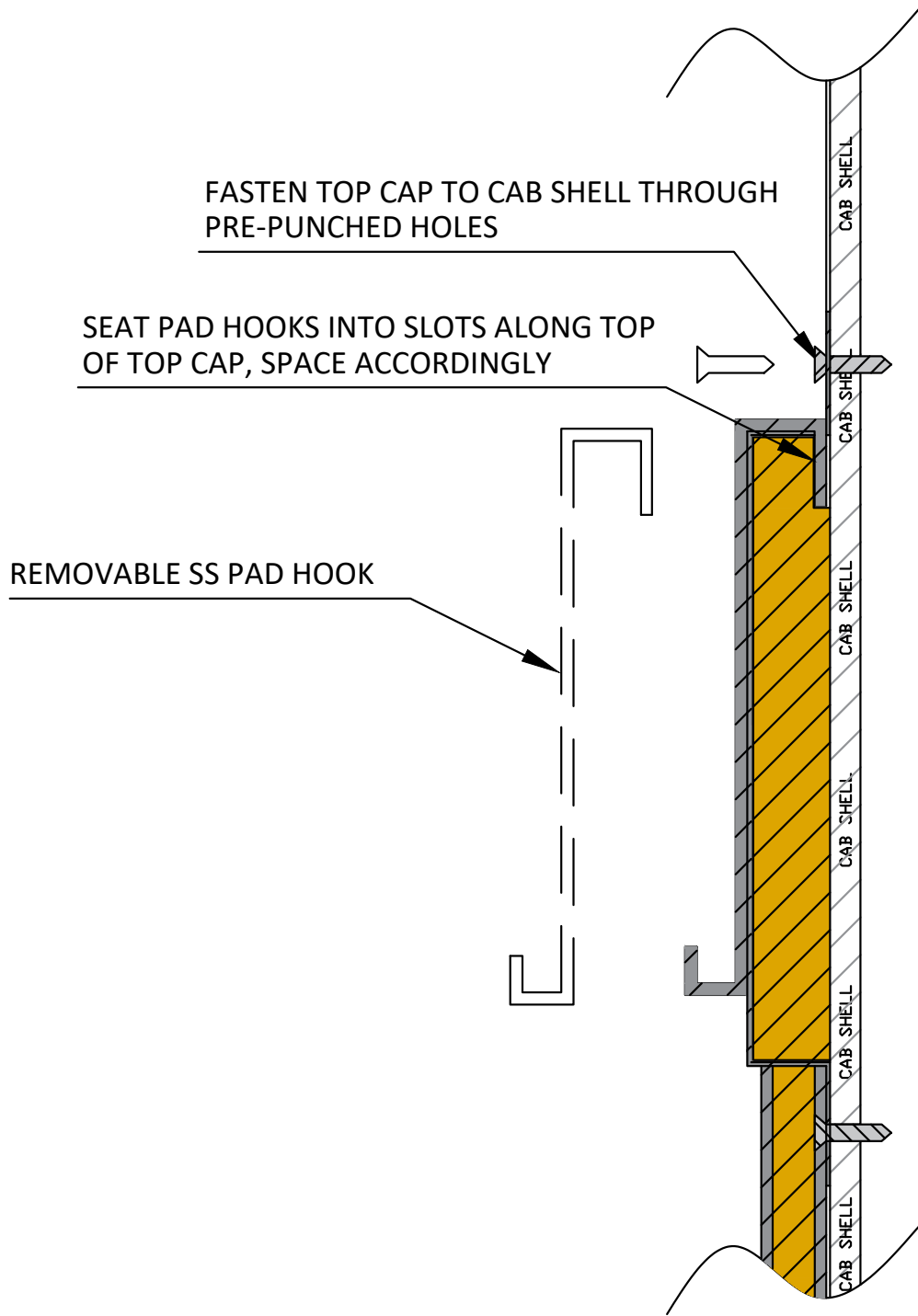

**Dia. 13**  
Top cap detail.

## SECTION 6: INSTALL ALTERNATE TOP CAP

- 6.1. If your cab does not have a drop ceiling, your Top Cap will arrive with a separate substrate. Fit and screw the substrate into the wall ensuring a small gap is left between to top of the C-Look panels for the thickness of the stainless steel (Dia. 14).

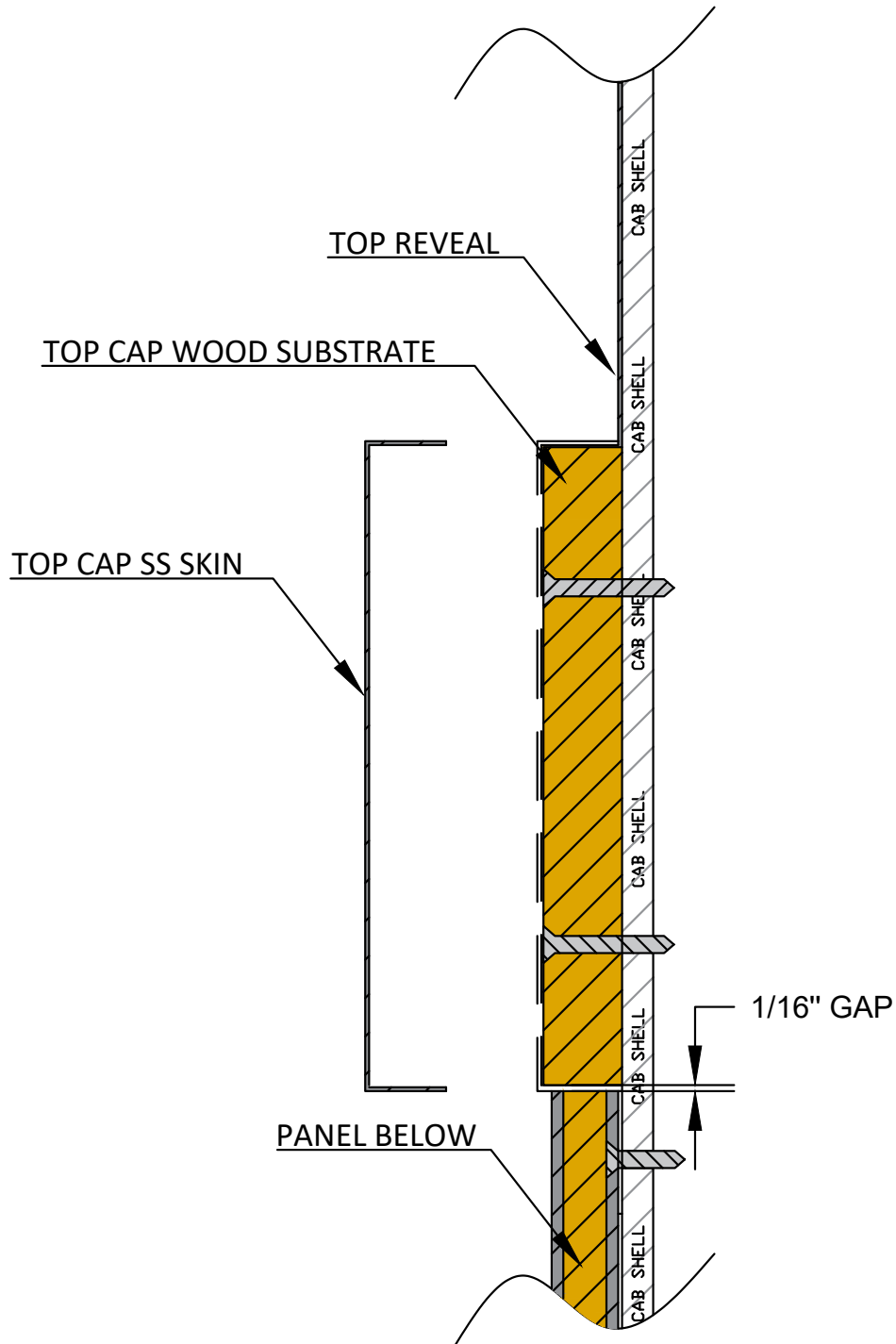

**Dia. 14**

Alternative top cap detail (no drop ceiling).

## SECTION 6: INSTALL ALTERNATE TOP CAP (CONTINUED)

- 6.2. Align the Top Cap with the panels and extrusions using the notches in the in the Top Cap skin, trim if necessary and secure the skin to the substrate with two way tape (Dia. 15 and 16).

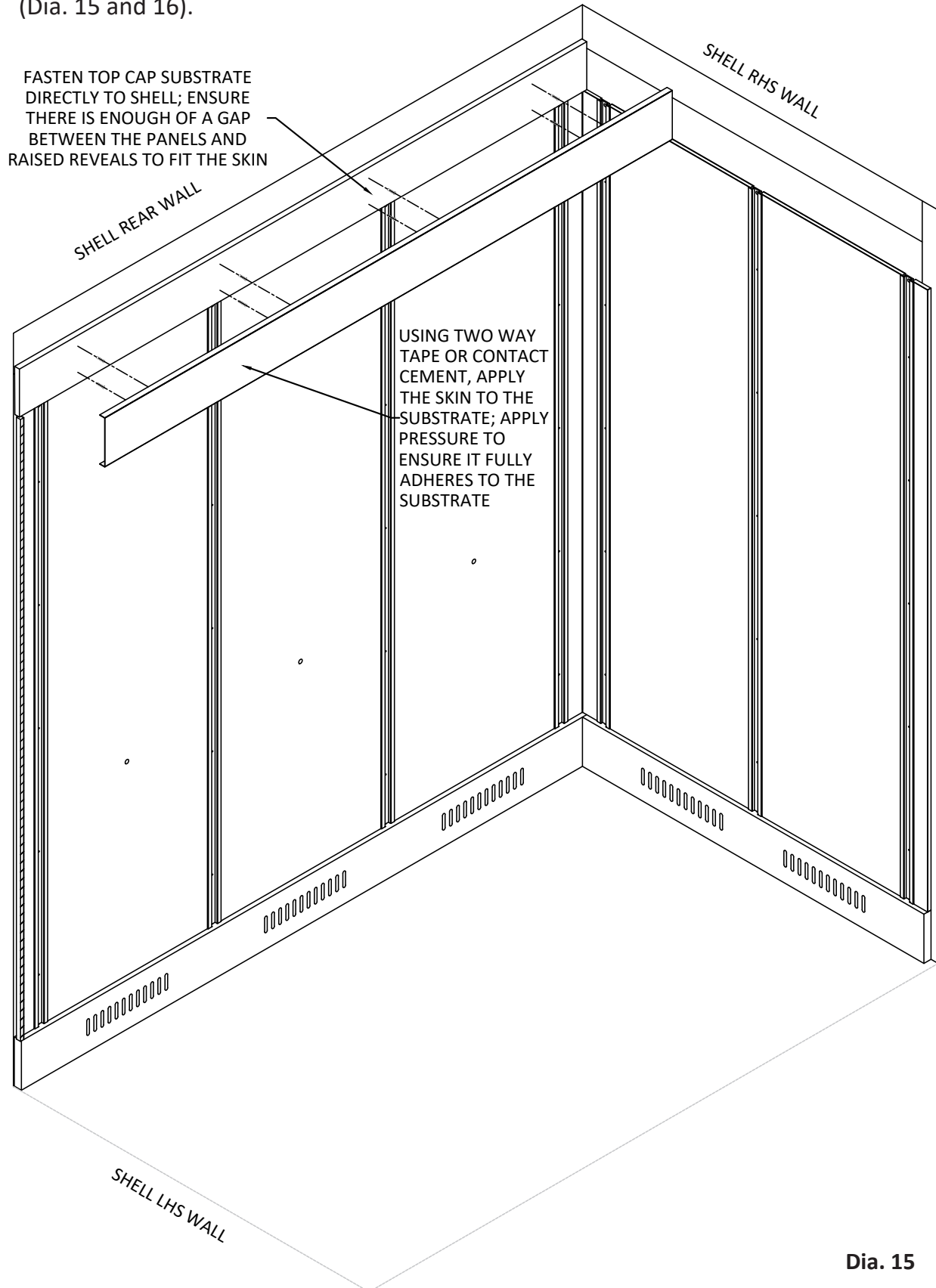

**Dia. 15**

## SECTION 6: INSTALL ALTERNATE TOP CAP (CONTINUED)

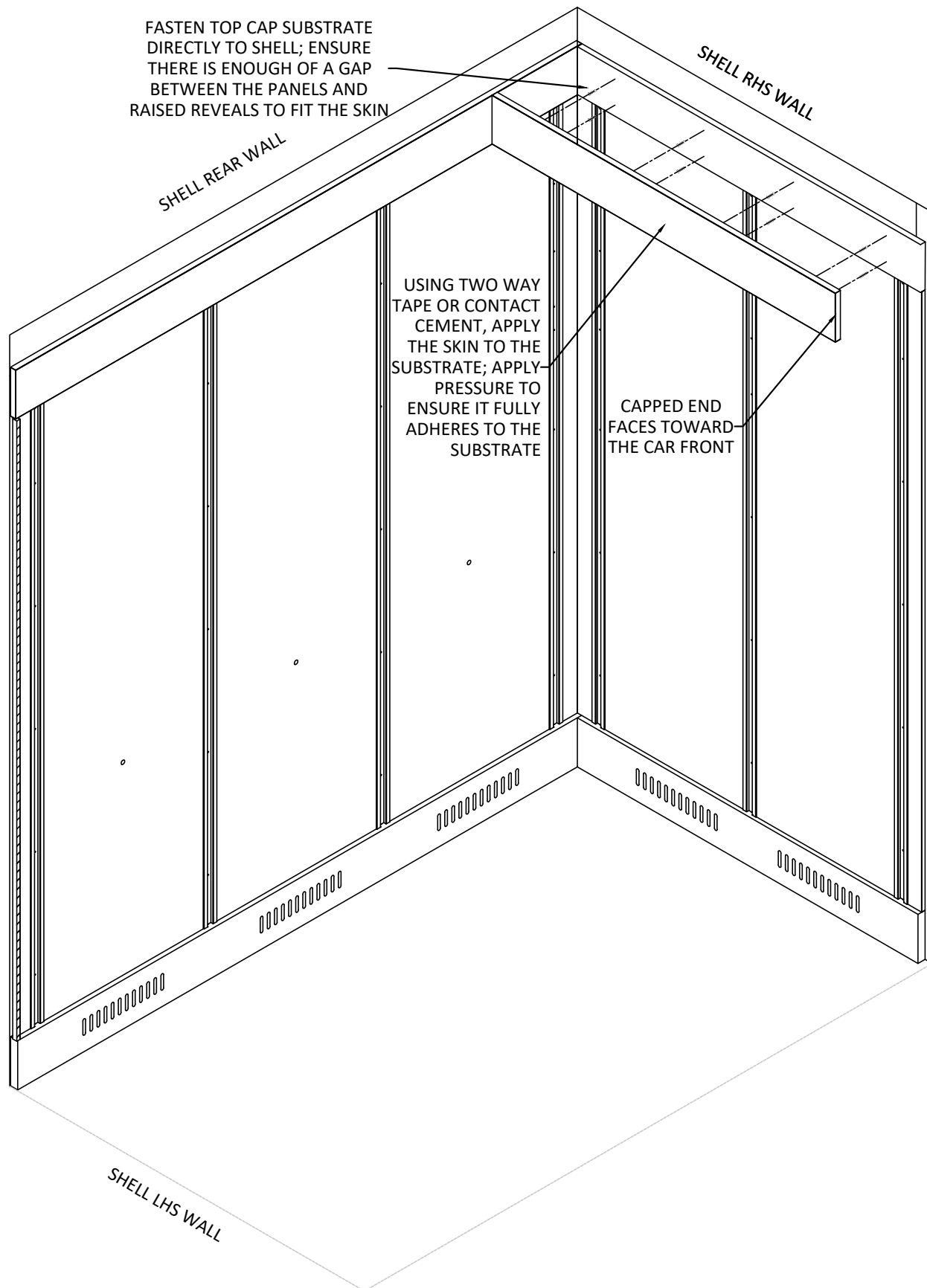

Dia. 16

## SECTION 7: FINISHING C-LOOK PANEL SYSTEM

- 7.1. Once all panels are installed, ensure finishes are secure on walls, add screws to extrusions if necessary.
- 7.2. Insert the screw cap inlays into the extrusion and gently tap the inlays until fully snapped into place (Dia. 17 and 18). Using a small block of wood between the cap inlay and your hammer helps to spread the load and protects the inlay during this process. Use caution not to damage the screw cap inlays.

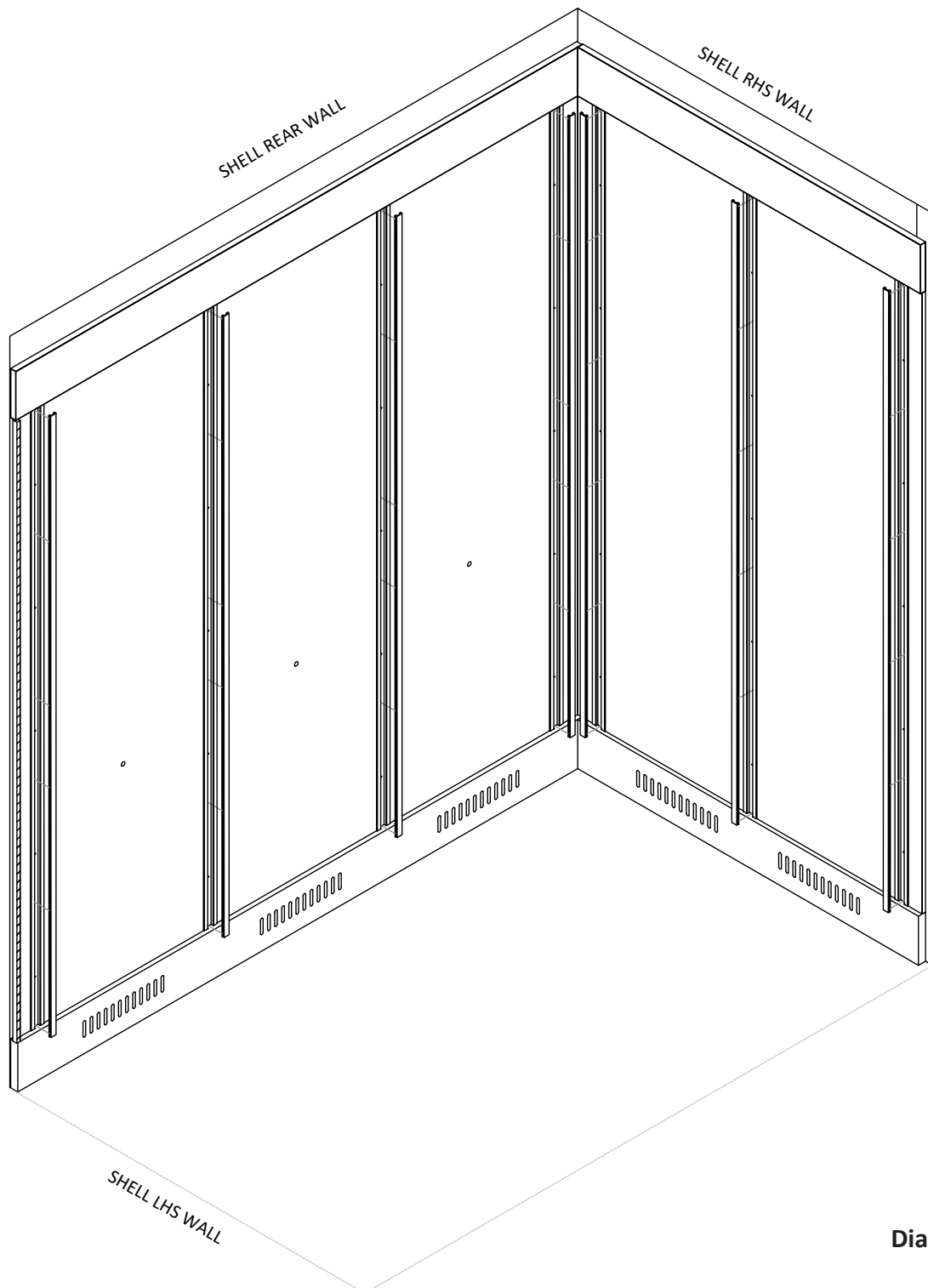

**Dia. 17**

SECTION 7: FINISHING C-LOOK PANEL SYSTEM (CONTINUED)

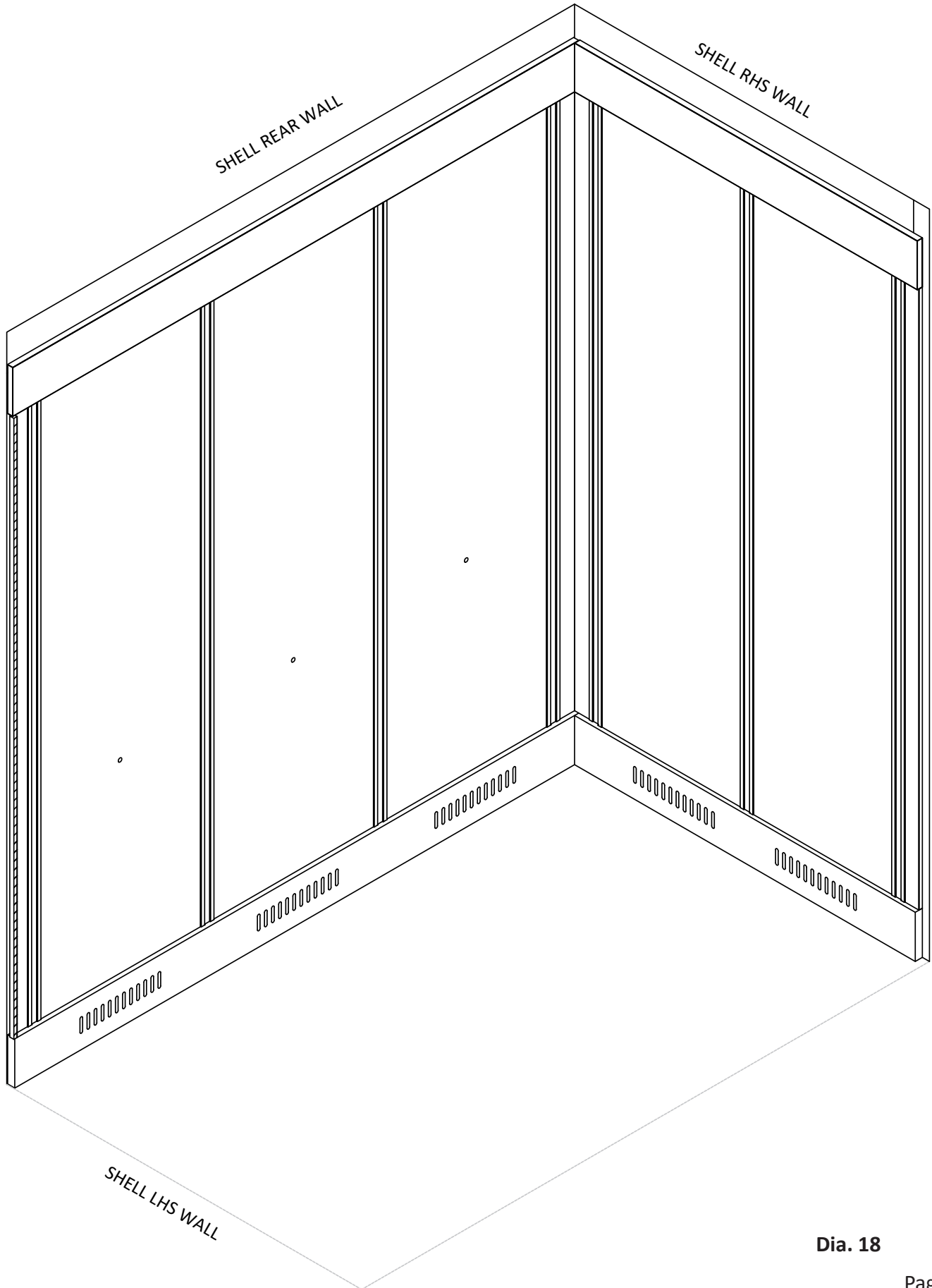

Dia. 18

## SECTION 8: INSTALL HANDRAILS

- 8.1. Locate the pre-drilled standoff locations in the C-Look panels.
- 8.2. Drill 1/2" holes through the pre-drilled holes through to the cab shell.
- 8.3. Insert and secure the provided togglers through the panels and the shell.
- 8.4. Place the flared end of a stainless steel standoff against the panel, centered on the toggler. Fasten this to the wall and panel with the 1/4"-20 bolts provided.
- 8.5. Slide the inserts into the standoff (inserts are attached to the handrail).
- 8.6. Secure the handrail to the standoff using the set screws provided. (Dia. 19)

### Installing the Toggles

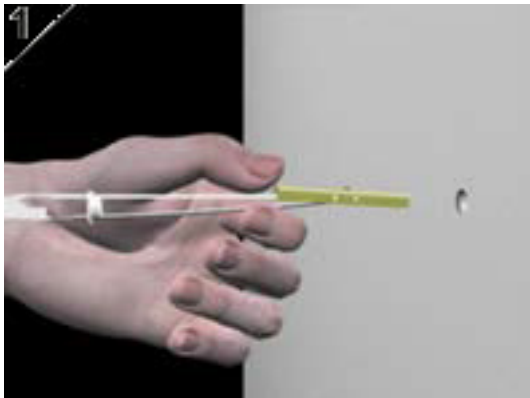

Drill a 1/2" hole. Hold the metal channel flat alongside plastic straps and slide channel through the metal channel through the hole. The minimum clearance behind the wall is 1 7/8".

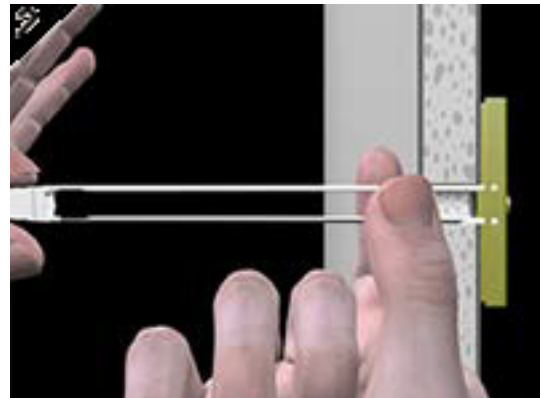

Hold the ends of straps between thumb and forefinger and pull toward you until channel rests flush behind wall. Slide plastic cap along straps with other hand until flange of cap is flush with the wall.

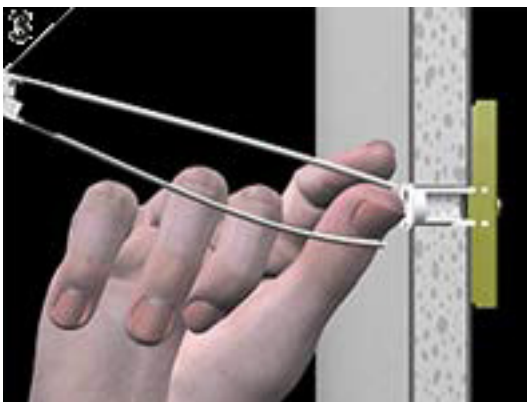

Snap straps at wall by pushing side to side snapping off straps level with flange cap.

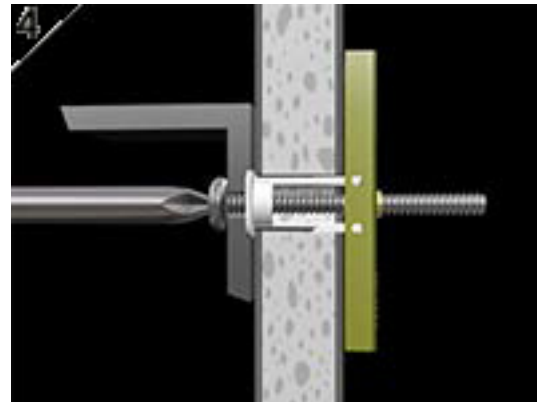

Place item over flange. Insert bolt through item and tighten until flush against item.

## SECTION 8: INSTALL HANDRAILS (CONTINUED)

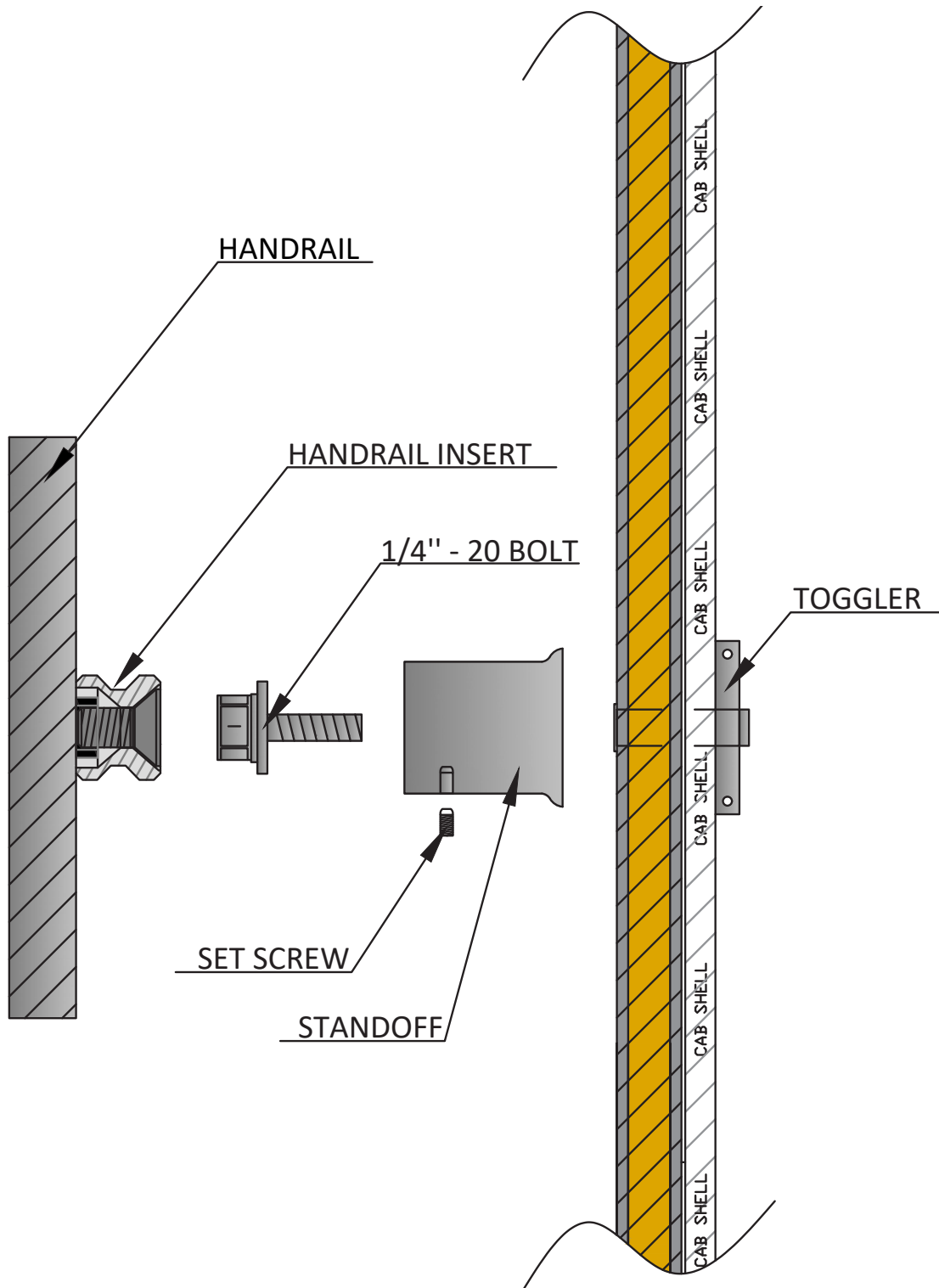

**Dia. 19**  
Attaching standoffs to handrail.



# SECTION 9: INSTALLATION COMPLETE

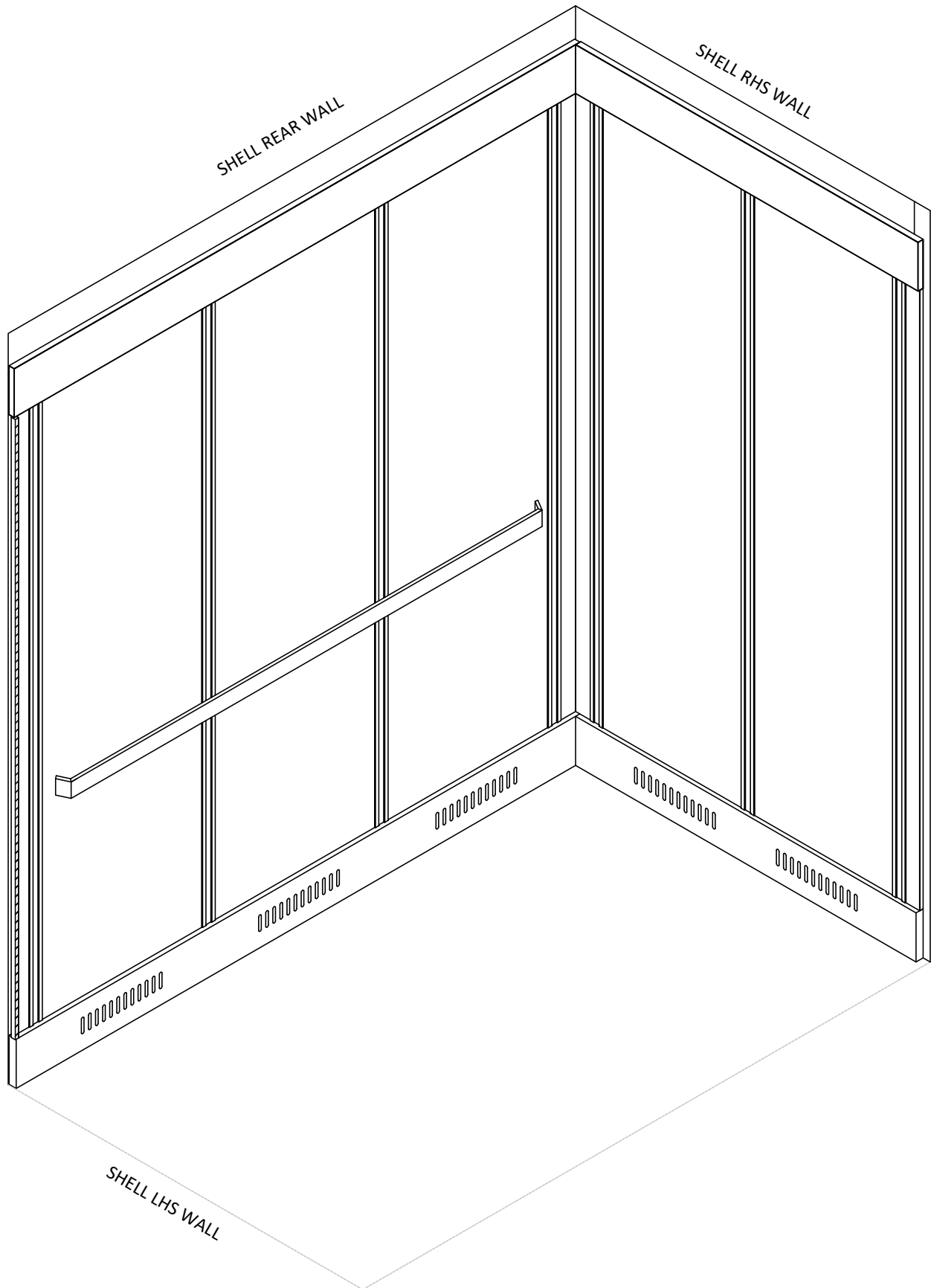

Dia. 20

## GLOSSARY

### **Canopy:**

The roof of the cab.

The top structural component of the shell.

The canopy houses the emergency hatch.

The canopy may have various electrical and mechanical components attached to its surfaces, both interior and exterior.

### **Non-Access Walls:**

Any elevator cab wall which does not have an entrance.

### **“C-Look© extrusion” (Patent Pending):**

A structural and decorative component of the C-Look© Panel System. The “C-Look© Extrusion” is an aluminum extrusion which secures the panels to the cab shell and covers the edges of the panel.

### **Screw Cap Inlay:**

A decorative component of the C-Look™ Panel System. The “Screw Cap Inlay” is a glass reinforced polycarbonate extrusion which covers the fasteners that would otherwise be visible inside the C-look Extrusions.

### **Reveals:**

Area of the elevator cab walls not covered by the panels. This area is usually covered with stainless steel or plastic laminate.

### **Strike Post or Slam Post:**

Part of the door frame on which the door closes.

### **Return Panel**

The wall of the cab adjacent to the entrance.

The return panel may contain the control operating panel (COP), phone box, and/or service panel.

The car door will slide behind the return panel.

For technical support on the C-Look Panel installation, please contact us at:

**Elevator Cab Renovations**  
**Office: (613) 745-4870**  
**Toll Free: 1-877-745-4870**  
ecr@elevatorcabs.ca

Office Hours : 6:30 AM to 3:30 PM Eastern Standard Time



# UNIVERSAL BAFFLE STRIP

TO BE UTILIZED WHEN ADDING  
VENTILATION SLOTS TO AN  
EXISTING CAB

## INSTALLATION INSTRUCTION

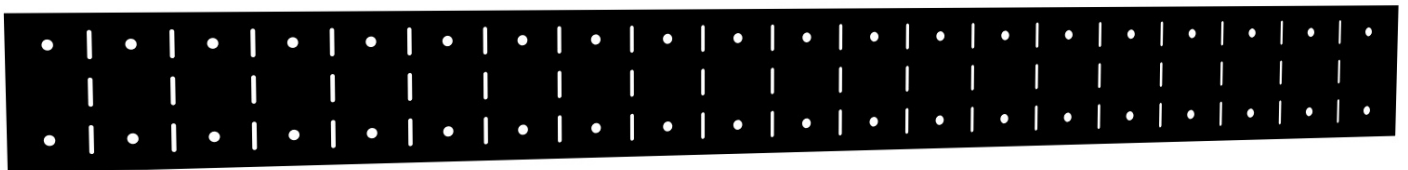

## TOOLS REQUIRED

- Rivets (max dia 3.2mm) 1/8"
- or
- Screws (max dia 3.2mm) 1/8"
- Drill
- Rivet Gun

## CAB COMPONENTS TO BE INSTALLED

Universal Baffle Strip(s) to be cut to size to suit shell opening(s)

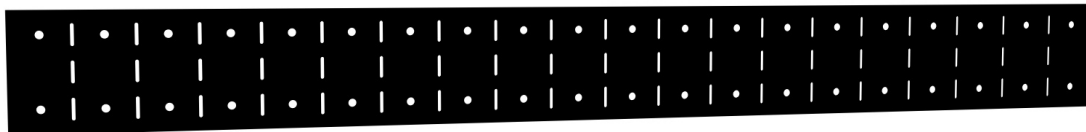

## OVERVIEW

- 0.1. Included with your package is a universal baffle strip. The universal baffle strip is designed to be installed into open vent slots in the cab shell in order to prevent material passing through the vent slots into the hoist way (as per ASME-Av17.1/B-44). The universal baffle strip is intended to be installed from the cab shell interior, prior to the installation of the cab finishes. Please refer to the following instructions to properly install your universal baffle strip.

## SECTION 1: PREPARE SITE FOR INSTALLATION

- 1.1. Once removal of the existing cab finishes are complete, determine if additional venting will be required.
- 1.2. If additional venting is required as per (as per ASME-A-17.1/B-44), locate and cut holes into the shell so that they will be hidden by the hollow vented kick plates (or hang on panels). Usually a 2'' (H) x 10'' (L) rectangular cut out is created off the finished floor for this purpose.
- 1.3. A typical side wall will have two cut-outs; a rear wall will typically have three cut outs.
- 1.4. Additional cut outs may also be required above the wall finishes close to the canopy (as per ASME-A-17.1/B-44).

## SECTION 2: INSTALL UNIVERSAL BAFFLE STRIP

- 2.1. Begin by determining the span of the vent to be filled. The universal baffle strip is segmented; this allows the material to be bent inwards and outwards. Starting at one end, create a 90 degree bend in the strip followed by a 90 degree bend back (Dia .1).

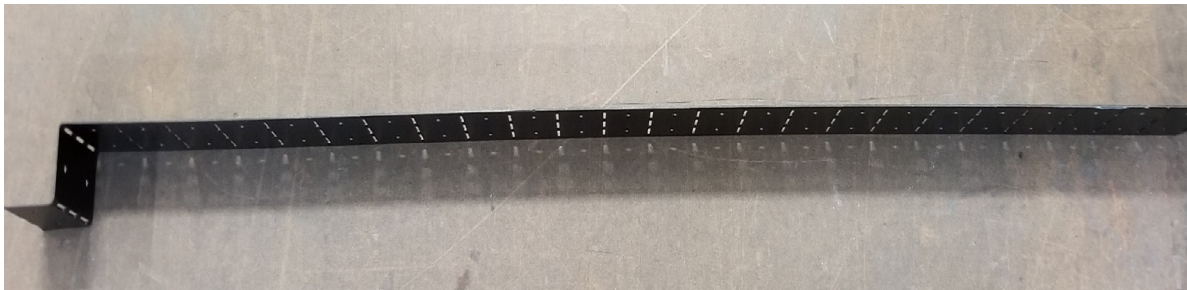

**Dia. 1**

Universal baffle strip, one end bent.

- 2.2. From this bend, follow the linkages until the span of the vent is reached (or as much as possible) and mirror the bends (Dia. 2). Use more or less linkages to suit the style and depth of the vent holes.

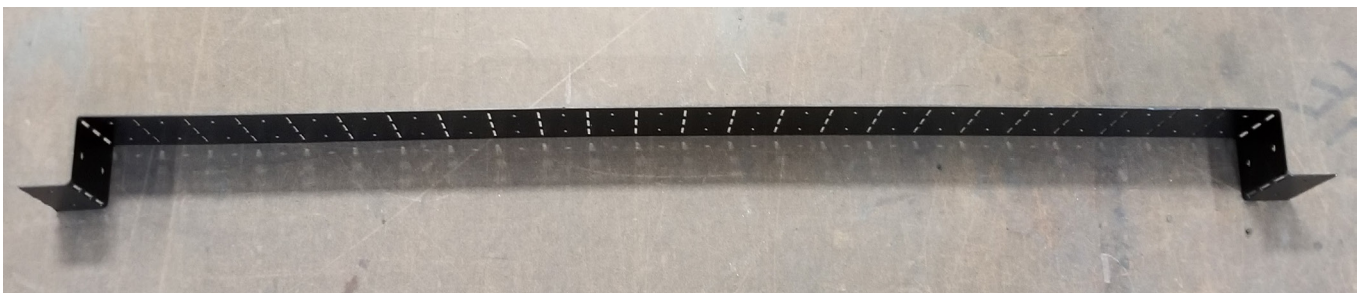

**Dia. 2**

Universal baffle strip, both ends bent, excess trimmed.

## SECTION 2: INSTALL UNIVERSAL BAFFLE STRIP ( CONTINUED)

- 2.3. Trim the excess material and retain the remainder of the baffle strip for additional vents if applicable.
- 2.4. Fit the baffle strip into the vent slot (Dia .3) and secure to the cab shell with screws or rivets (Dia .4).



**Dia. 3**  
Universal baffle strip, ready for installation.

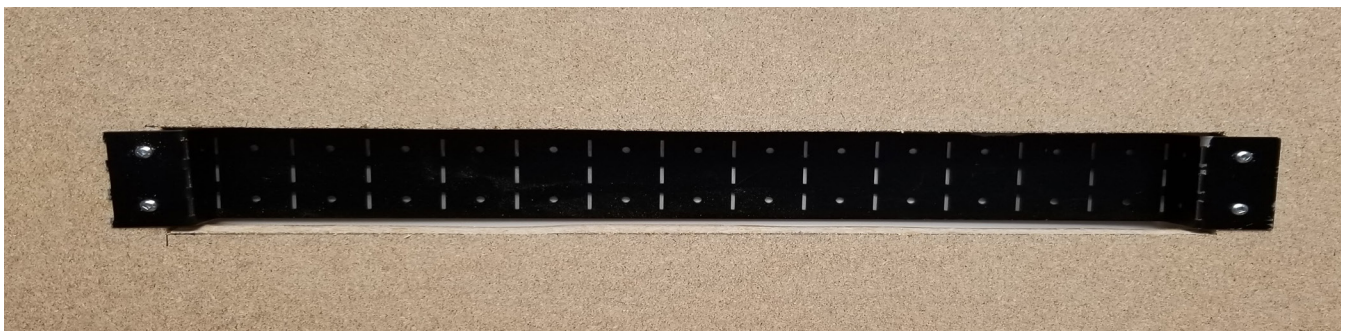

**Dia. 4**  
Universal baffle strip installed, secured with fasteners.

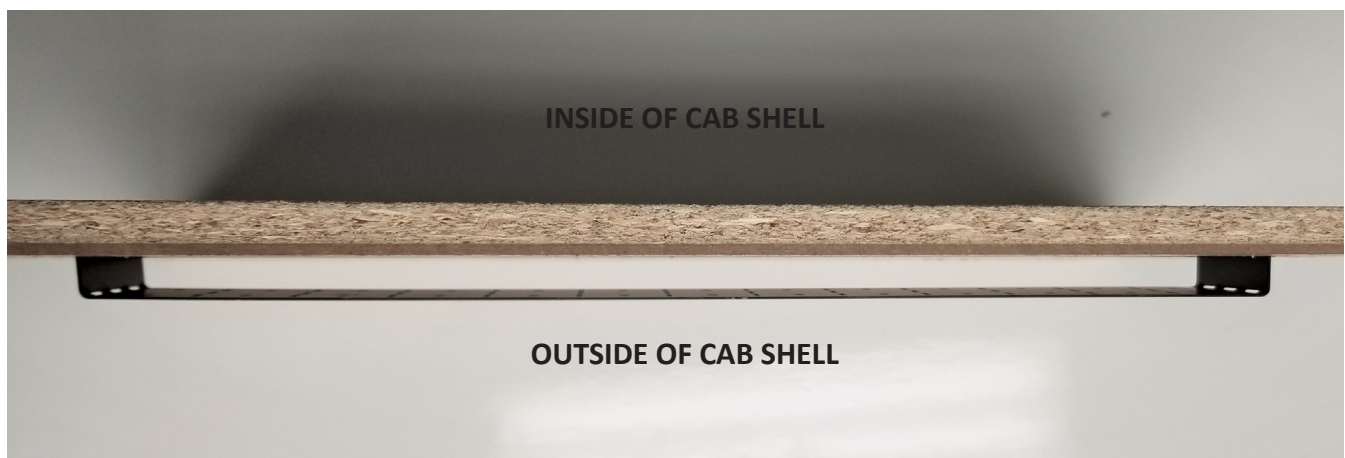

**Dia. 5**  
Section view of universal baffle strip.

- 2.5. Once the vent slots and baffle strip are in place, proceed with installing the new cab finishes.